

*Sereni*  
FURNISHINGS

ASSEMBLY  
INSTRUCTIONS

# Tetras 150cm Bed

## ASSEMBLY INSTRUCTIONS

**20 Mins**  
Approximate  
Assembly Time



2 Person  
Assembly

**2x2mtr**  
Required  
Assembly Area

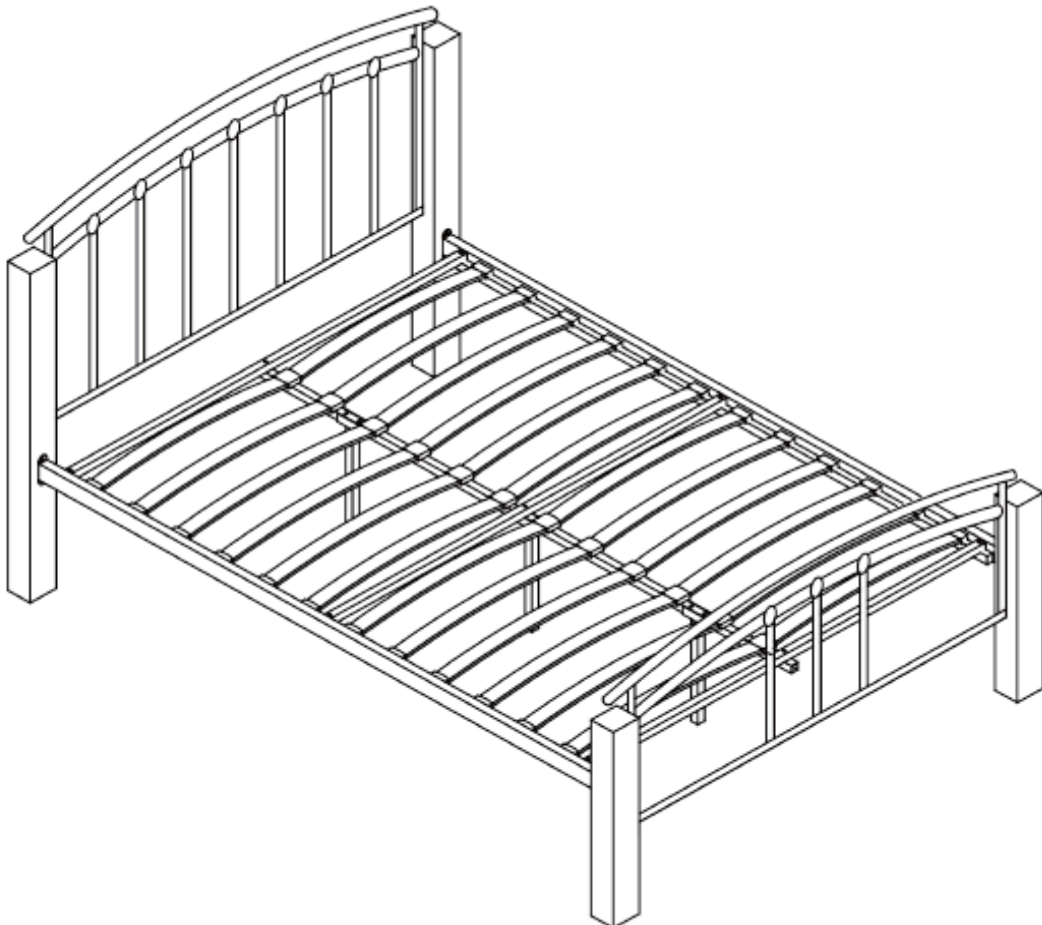

**IMPORTANT :**

Please inspect all items **BEFORE** assembly. If for any reason you need to return this item, you must return it in it's original packaging. Assembled items **CANNOT** be returned.



## TIPS & IMPORTANT SAFETY

### Top Tips before you start!

1. Please check that all parts are present before you start the assembly of your furniture, as once assembled, the furniture CANNOT be returned.
2. For ease and speed of assembly, we recommend that before you commence each step of the assembly, that you identify all the parts required for that step.
3. We recommend that, where possible, all items are assembled near to the area in which they will be placed in use, to avoid moving the product unnecessarily once assembled.
4. For the protection of your furniture, particularly items of high gloss finish, we recommend that the product is placed on a protected surface during assembly to prevent any damage.
5. During assembly please take care not to over-tighten any fittings, as this may damage the product.

### SAFETY

1. This product is heavy, take extreme care when lifting to avoid personal injury or damage to the product.
2. Choking hazard - Keep small components away from young children. We recommend children are kept well away from the assembly area.



# WARNING & RECOMMENDATIONS

## WARNING

1. Use this product for its specified purpose and function only.
2. If parts are missing, broken, damaged or worn, stop using this product until you have repaired it fully.
3. Make sure this product is placed on a flat level surface and is stable before use. This product must make full contact with the surface before use.
4. This product is heavy. Use an assistant when lifting.

**FAILURE TO FOLLOW THESE WARNINGS COULD RESULT IN SERIOUS INJURY.**

## RECOMMENDATIONS

1. Please take the time to carefully read through the whole of these instructions before you commence with assembly.
2. Please periodically check all fittings and re-tighten as necessary.
3. Wipe occasionally with a soft cloth dampened with water. Then buff with a dry clean soft cloth.
4. Never allow any kind of liquid to remain on your furniture. Absorption can cause wood to warp or finishes to de-laminate.
5. Please check that the centre support rail is securely fixed in place.
6. Keep these instructions for future reference.

### 1 PARTS LIST

① X1 pc

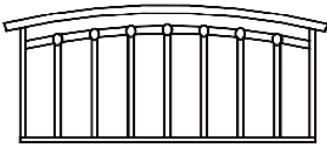

② X1 pc



③ X2 pcs



④ X3 pcs



⑤ X24 pcs



⑥ X1 pc



⑦ X3 pcs



⑧ X2 pcs

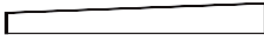

⑨ X2 pcs

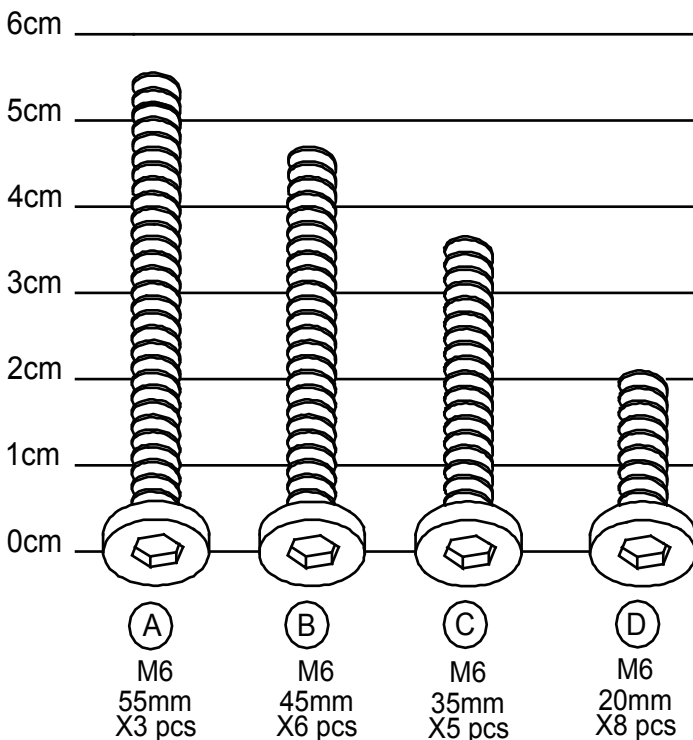
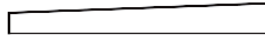

⑤ E X12 pcs

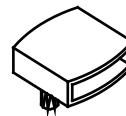

⑥ F X1 pc

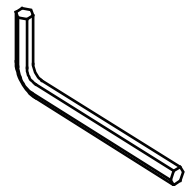

⑦ G X24 pcs

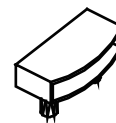

⑧ H X14 pcs



⑨ I X1 pc

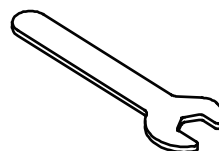

# Tetras 150cm Bed ASSEMBLY INSTRUCTIONS

## STAGE 1

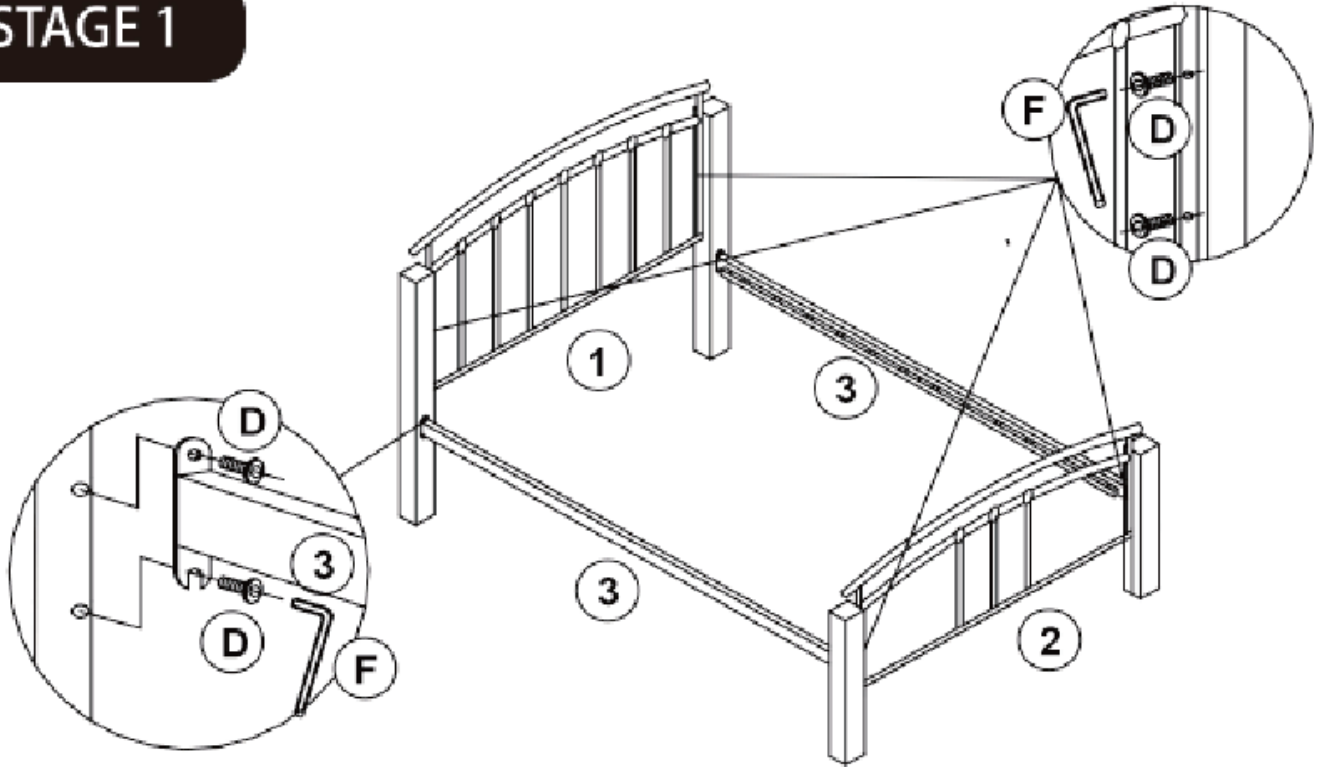

## STAGE 2

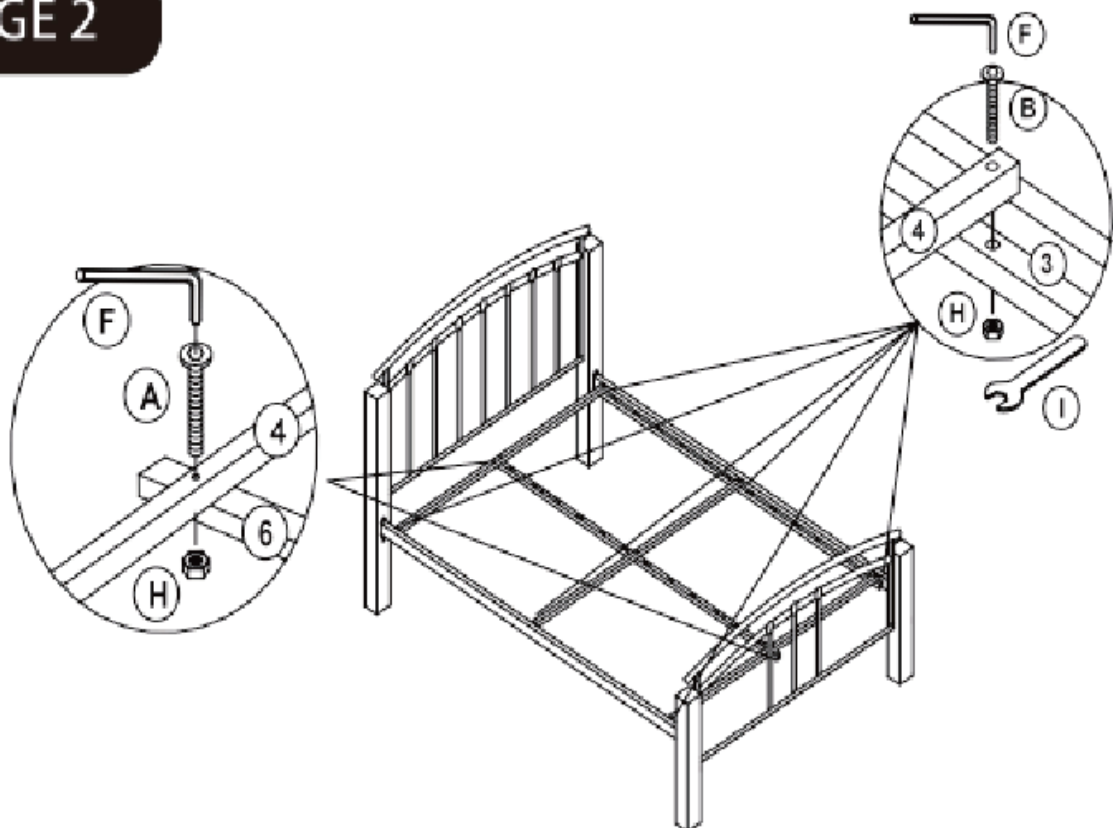

# Tetras 150cm Bed ASSEMBLY INSTRUCTIONS

## STAGE 3

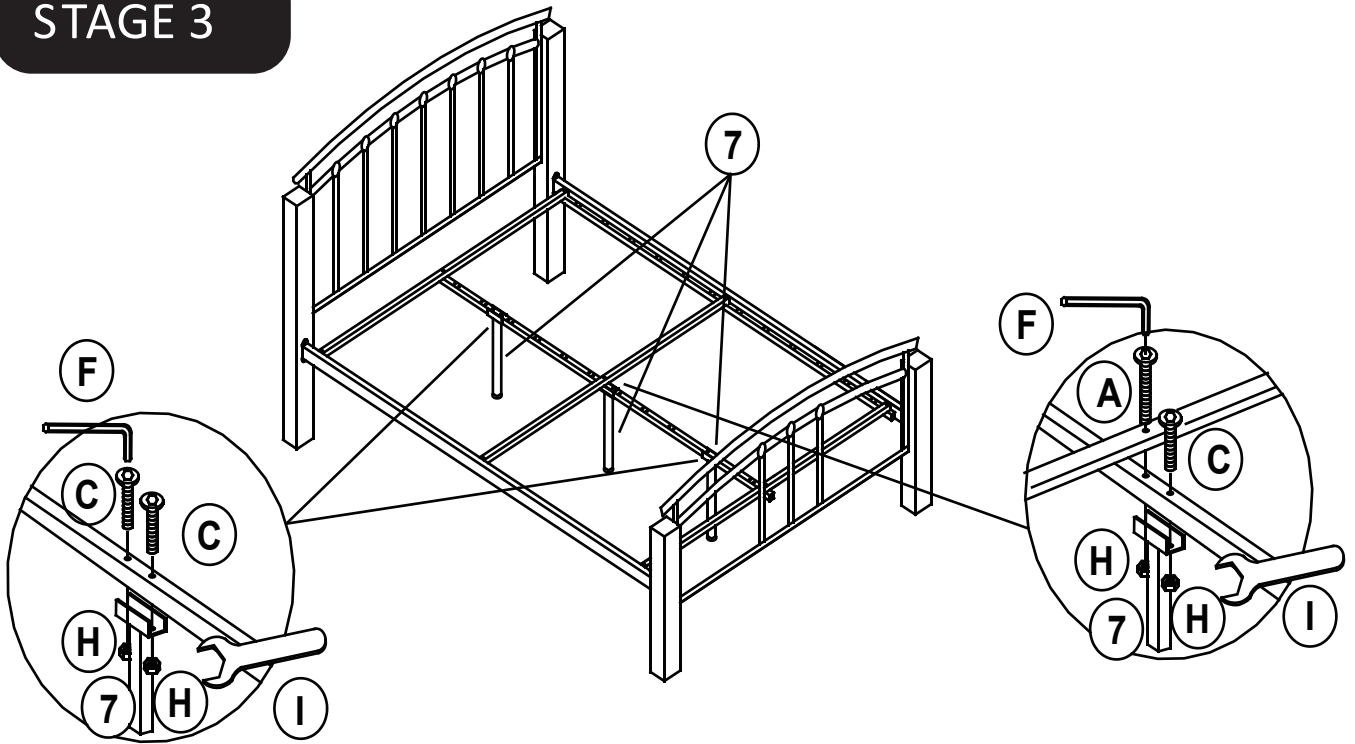

## STAGE 4

