

ASSEMBLY INSTRUCTION FOR NCWC-4-748H-WSR-BW

Note:
 • Read Instructions carefully.
 • Carefully identify each component especially those that are similar.
 • Separate and identify each component from the hardware pack and rest each one in its proper location before fastening.

TOOL REQUIRED

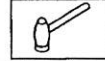

Step 1

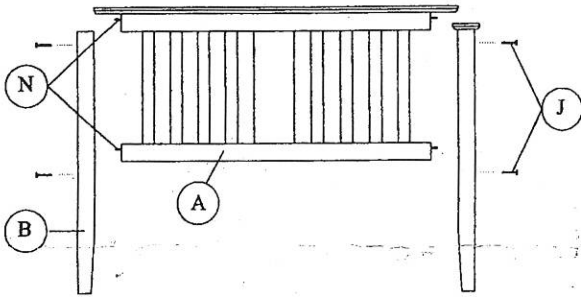

Assemble the bed frame component and tighten all bolt.

Step 5

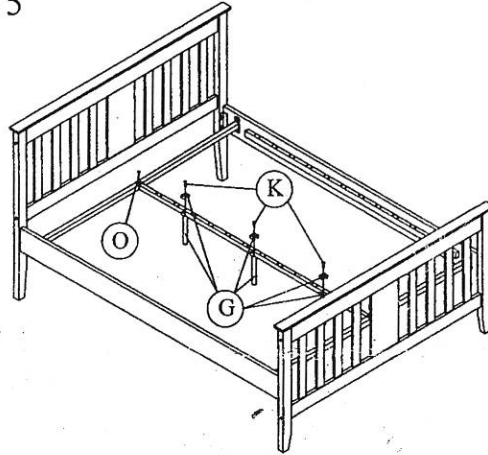

Fix center bar with bolt 'O' and tighten it. After that fix in support leg with bolt 'K'.

Step 2

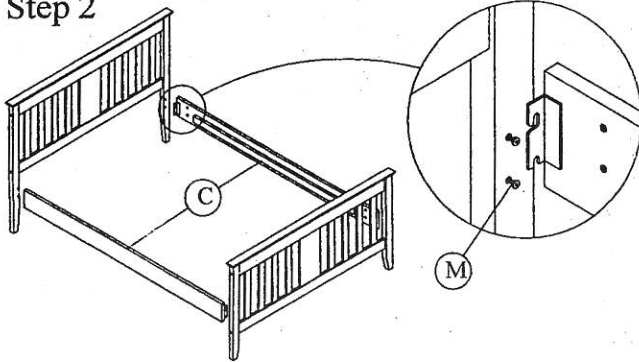

Hook the side rail to bolt as shown and don't tighten the bolt yet.

Step 6

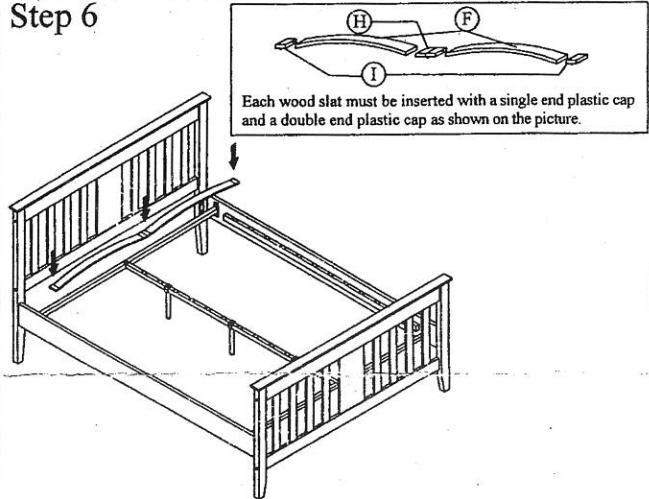

Each wood slat must be inserted with a single end plastic cap and a double end plastic cap as shown on the picture.

Step 3

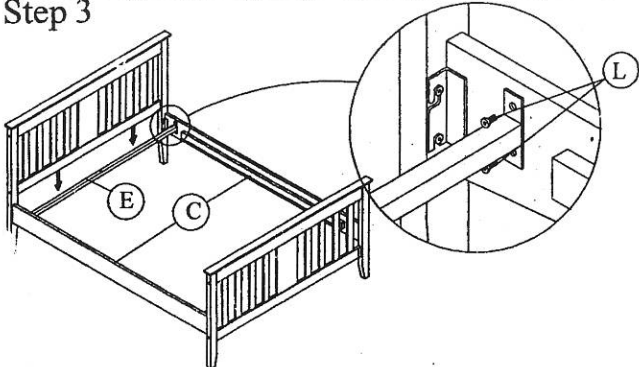

Put in cross bars and fix in bolt 'L' as shown in diagram and tighten all bolts.

Step 7

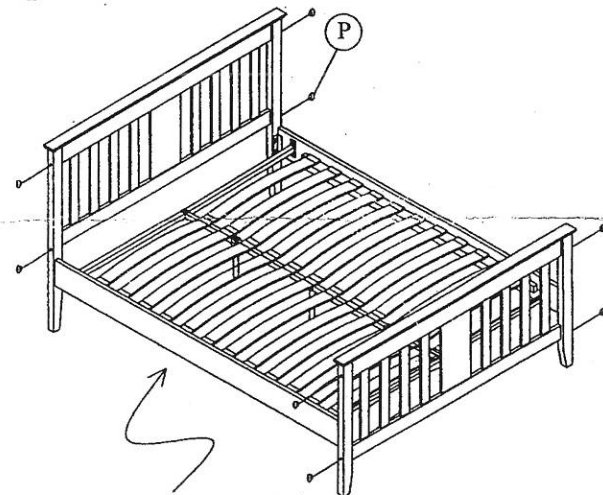

Complete Assembly

Step 4

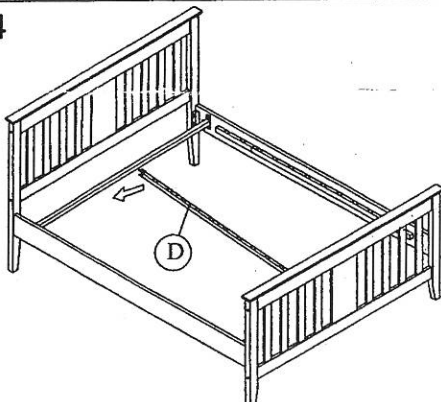









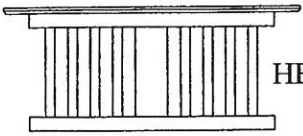

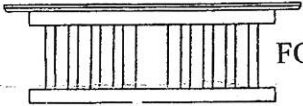



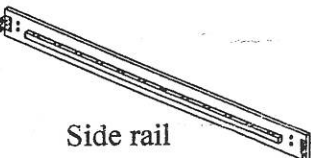

Fix center bar 'D' to cross bar 'E' by follow like diagram as shown.

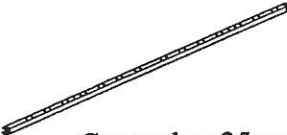
Make sure all bolts are tighten.
 At last insert wood button (P) as shown.

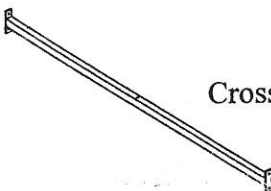
Please follow our assembly instruction procedure for easier assemble.

PARTS & HARDWARE LIST FOR NCWC-4748H-WSR-BW

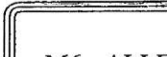
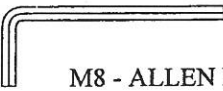
NO	PART	QTY	NO	PART	QTY
A	 HEAD FRAME	1 pc	G	 SUPPORT LEG	3 pcs
	 FOOT FRAME	1 pc	H	 Double end plastic cap	12 pcs
B	 HEAD POST	2 pcs	I	 Single end plastic cap	24 pcs
	 FOOT POST	2 pcs	J	 M6x80mm (4pcs assembled)	8 pcs
C	 Side rail	2pcs	K	 M8x40mm (assembled)	3 pcs
			L	 M6x15mm	8 pcs
D	 Center bar 25mm x 25mm	1pc	M	 M8x25mm	8 pcs
			N	 Wood Dowel (4pcs assembled)	8 pcs
E	 Cross bar	2pcs	O	 M6x30mm	2 pcs
			P	 Wood Button	8 pcs
F	 Wood slat	24pcs		 M6 - ALLEN KEY	1 pc
				 M8 - ALLEN KEY	1 pc