

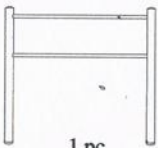

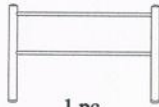

MODEL :METAL POST
 SIZE :SINGLE BED







DAISY 90cm BED and GUEST BED

ASSEMBLY INSTRUCTIONS

Part List

HEAD BOARD  1 pc	FOOT BOARD  1 pc	SIDE RAIL  2 pcs	CENTRE CROSS RAIL  2 HOLE 1 pc	SPRUNG WOOD  12 pcs
---	--	--	---	--

Hardware

SINGLE CONNECTOR  24 pcs	M6 X 20mm  8 pcs	M6 X 40mm  2 pcs	M6 HEX NUT  2 pcs	ALLEN KEY M4  1 pc	SPANNER  1 pc
--	--	--	---	--	---

Step 1

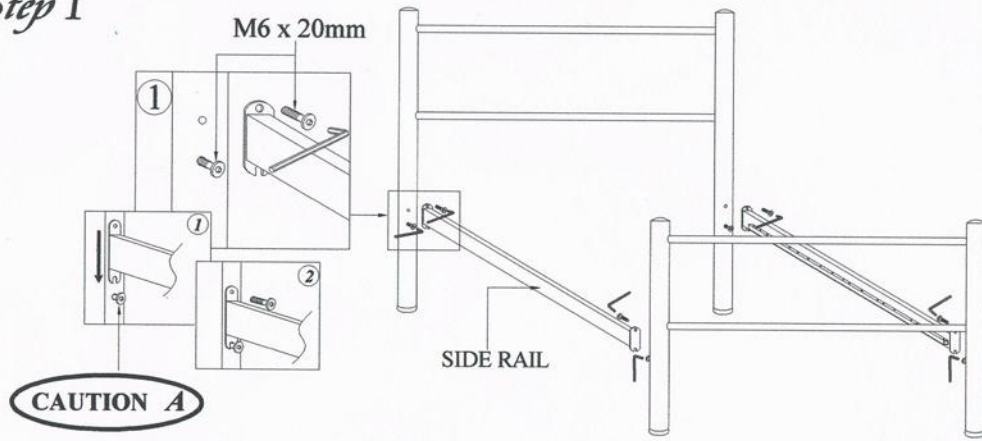

Step 3

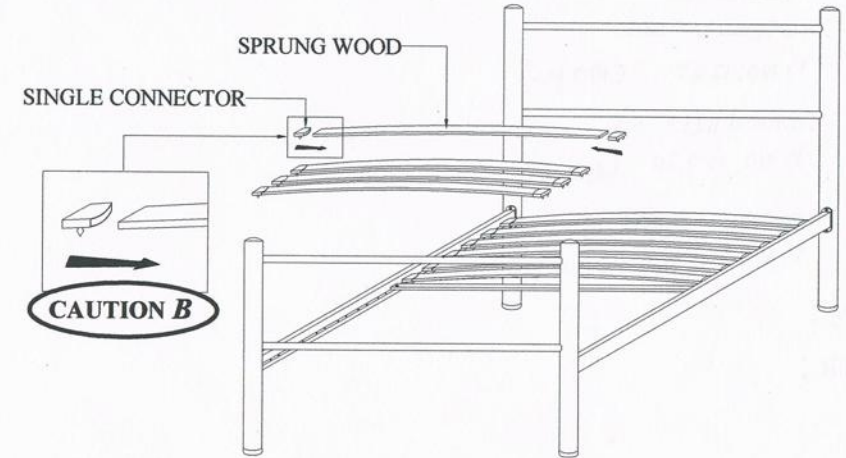

Step 2

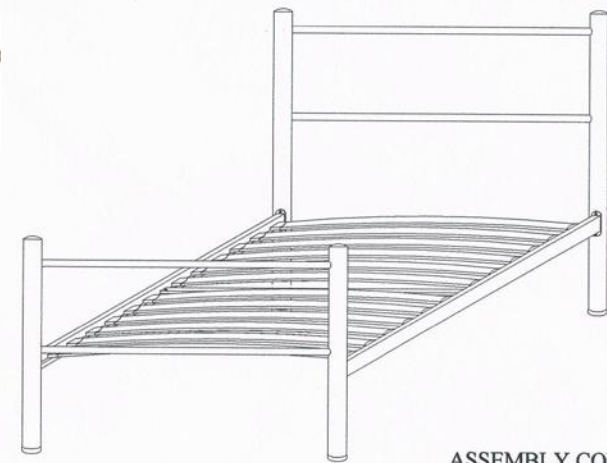
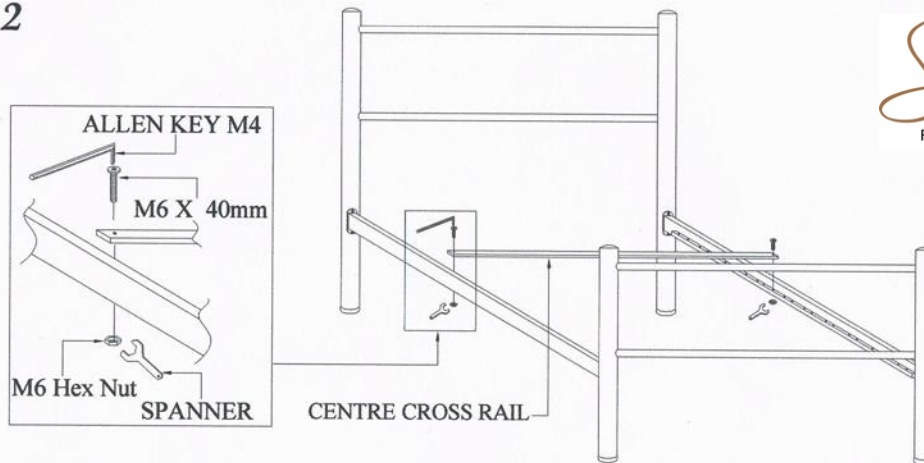

A

CAUTION!
Do not tight screw, left around 5mm before completely assembled.

B

CAUTION!
Make sure sprung wood is fully push tightly into single connector, if not by slowly knock single connector until tight into sprung wood.

IMPORTANT!

*Tighten all screw and complete product as shown
 *Ensure cross rails are located in the side rails before placing the mattress on the bed frame"

ATTENTION!











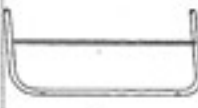



- o Wipe clean using a soft damp cloth followed by a dry cloth.
- o Do not use abrasives or cleaning products which may contain ammonia or solvents.
- o Take care when handling or moving the furniture. Careless handling can damage wooden furniture, try to lift rather than drag.

MODEL : GUEST BED
 SIZE : SINGLE

ASSEMBLY INSTRUCTIONS

Part List

Hardware

METAL LEG	SIDE RAIL	CROSS RAIL	CASTER	SPRUNG WOOD	SINGLE CONNECTOR	M8 X 60mm	M6 X 60mm	M6 X 40mm	M6 HEX NUT	M6 LOCK NUT	M6 FLAT WASHER	M8 HEX NUT	M8 LOCK NUT	M8 FLAT WASHER	ALLEN KEY M4	ALLEN KEY M5	SPANNER # 10	SPANNER # 12
																		
2 pcs	2 pcs	4 pcs	4 pcs	12 pcs	24 pcs	4 pcs	4 pcs	8 pcs	12 pcs	4 pcs	16 pcs	4 pcs	4 pcs	8 pcs	1 pcs	1 pcs	1 pcs	1 pcs

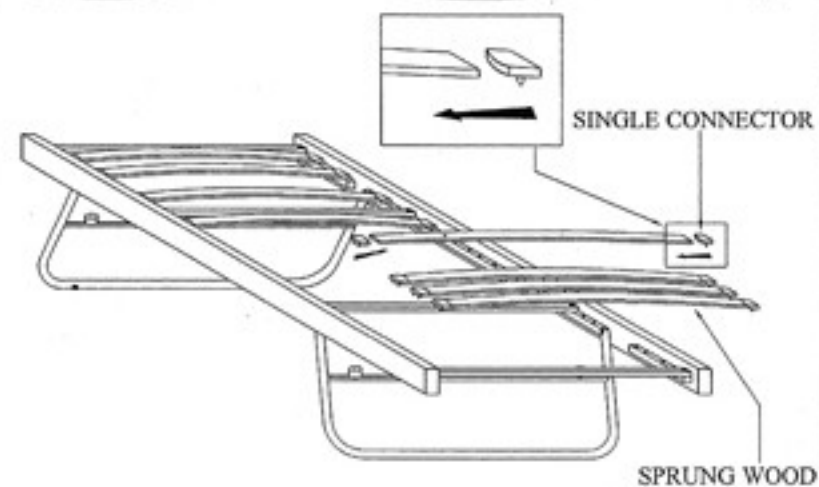
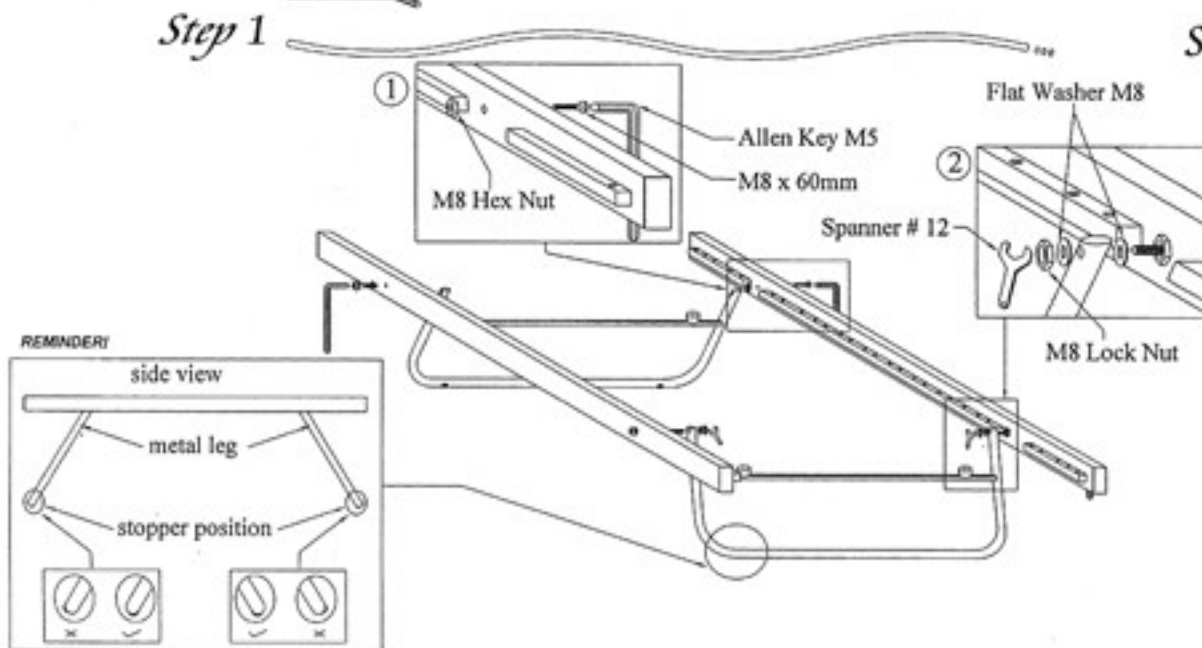
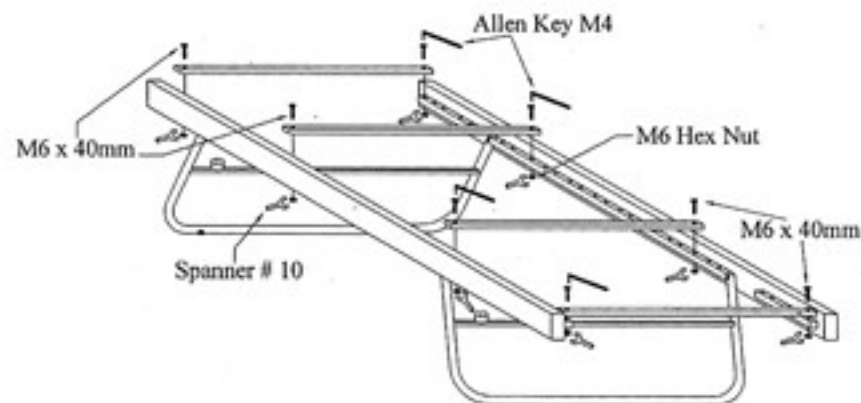
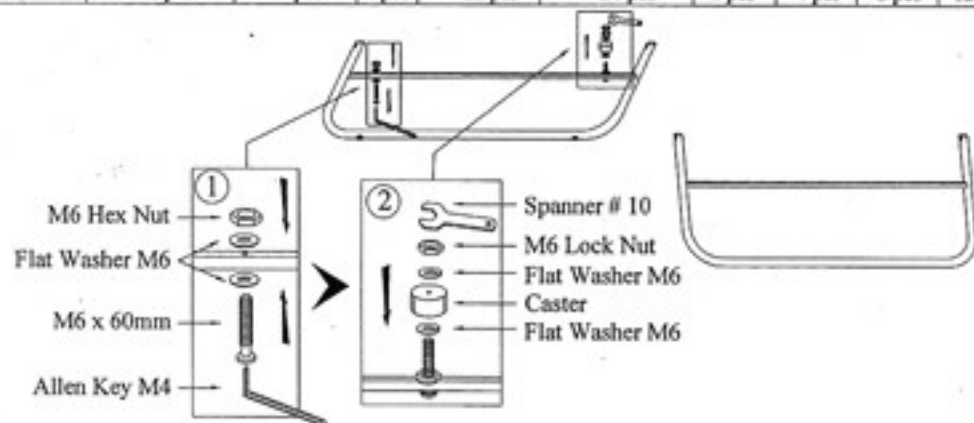

REMINDE!
 * Tighten all screw and complete product as shown
 * Ensure cross rails are located in the side rails before placing the mattress on the bed frame