

# OPORTO PLUS DINING TABLE

## Assembly Instructions

### IMPORTANT

Please read before you continue further.

PLEASE KEEP THE ORIGINAL PACKAGING UNTIL THE ITEM IS FULLY ASSEMBLED AND IN PLACE. IN THE UNLIKELY EVENT THAT YOU NEED TO RETURN YOUR PRODUCT, IT MUST BE RETURNED IN ITS ORIGINAL PACKAGING TO AVOID FURTHER DAMAGE. FAILURE TO FOLLOW THESE PROCEDURES, NO RETURNS WILL BE ACCEPTED.

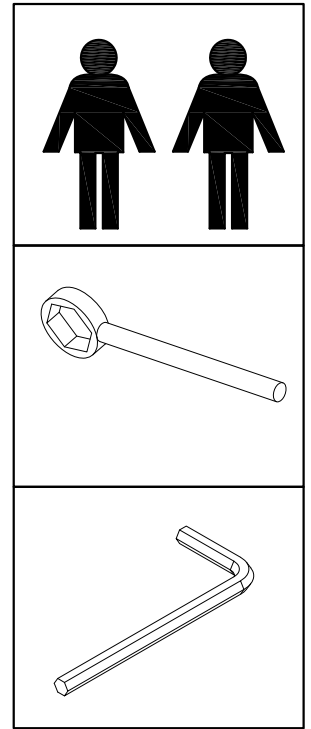
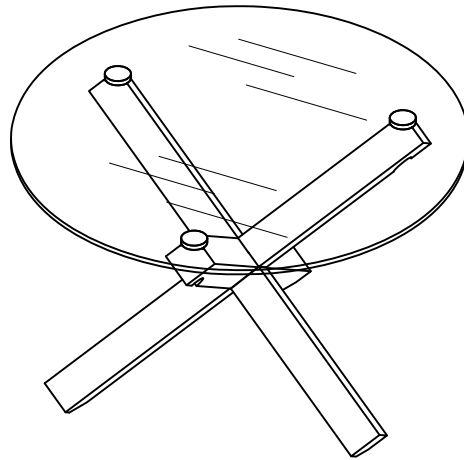

Carefully check that you have all the components prior to assembly.







Unpack and assemble this furniture on a clean, flat, protective surface in the room it will be used.

We recommend that the packaging is used to protect the surfaces during assembly.

It may be necessary to tighten any fittings from time to time depending on use, this is normal with flat pack furniture.

Save all packing material until assembly is complete to avoid accidentally discarding smaller parts or hardware.

Please keep these instructions safe in case you wish to look at in the future.

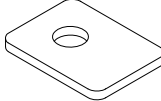
<b>A</b> Ø8 x 55(mm): 03 PCS 	<b>B</b> Ø8 x 15(mm): 03 PCS 	<b>C</b> Ø10/Ø26(mm): 04 PCS 	<b>D</b> Ø4(mm): 01 PC 
<b>E</b> Ø17 (mm):1 PC 	<b>F</b> Ø10(mm): 02 PCS 	<b>G</b> 30x45(mm): 01 PC 	<b>H</b> Ø10(mm): 01 PC 