

# PC030A HOLLYWOOD OTTOMAN BED

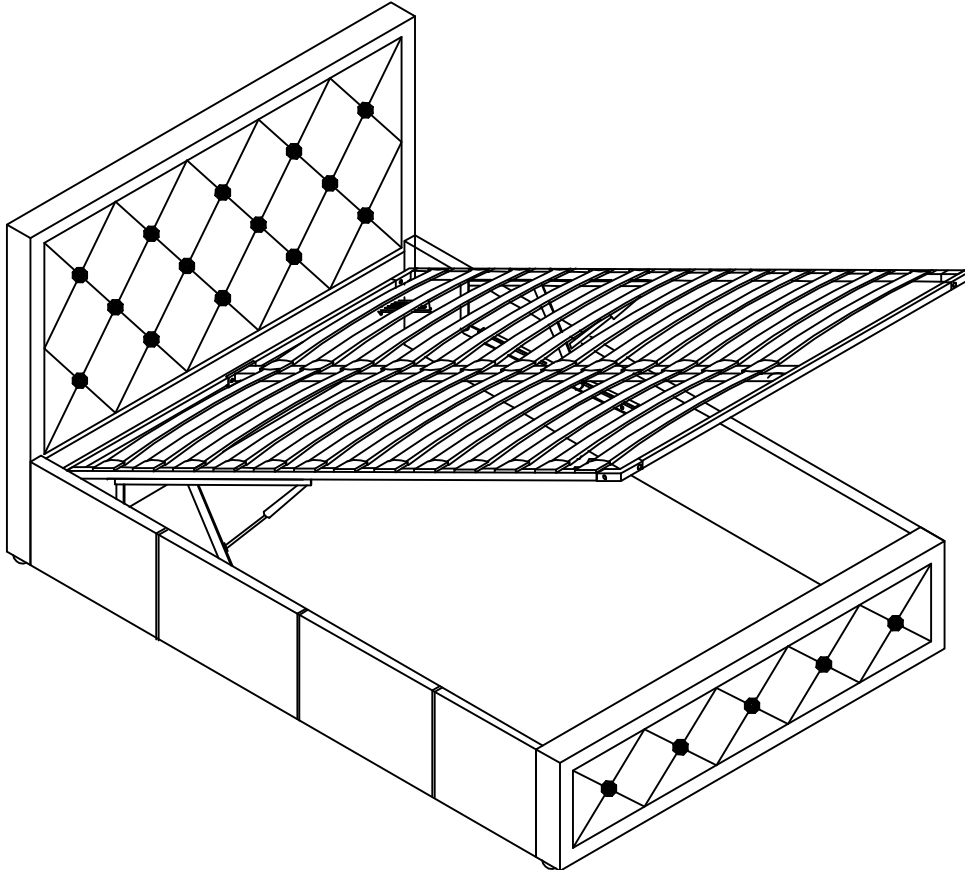

2080mm×1030mm×1110mm 3ft Single  
2080mm×1330mm×1110mm 4ft Small Double  
2080mm×1480mm×1110mm 4ft 6 Double  
2180mm×1630mm×1110mm 5ft King

GFW Limited  
2014.07  
Page 1 of 8

# PC030A HOLLYWOOD OTTOMAN BED

## Important Information

### INFORMATION

- **Important - read carefully - retain these instructions for future reference.**
- **Due to the size of this product we recommend that it is assembled in the room intended for use.**
- **When you are ready to start, make sure that you have the right tools, plenty of space and a clean, dry area for assembly.**
- **Unwrap all packaging materials and place the components on top of the carton box or on a clean floor to prevent it from scratching.**
- **Check the pack and make sure you have all the parts listed.**
- **Ensure that this product is fully assembled and secured as illustrated before use.**
- **Check all screws or bolts are tightened and inspect regularly.**
- **This product should only be used on firm, level ground.**
- **Keep small parts out of reach of children.**
- **Make sure the legs remain in contact with the ground.**
- **Please dismantle for transportation**
- **Tools not included.**

### WARNINGS

- **This product is intended for a maximum person's weight of 100kg per side. Do not exceed this weight.**
- **Do not use power tools to construct this product.**
- **Do not tighten screws until fully assembled.**
- **Do not over tighten screws or bolts.**
- **Do not use this product if parts are missing, damaged or worn.**
- **Do not stand on the product.**
- **Please pay particular attention when children or animals are present to ensure that no accidental entrapment occurs whilst operating this product**

### CARE INFORMATION





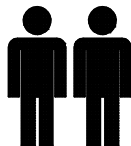





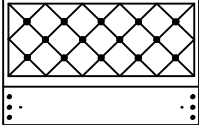
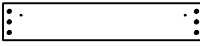

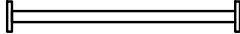

- **Never use scourers, abrasives or chemical cleaners.**
- **To clean wipe with a sponge and warm soapy water. Do not use solvent based cleaners or detergents as they can bleach or damage the product.**

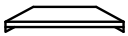
**2 person build**













# PC030A HOLLYWOOD OTTOMAN BED

## PARTS

			
<b>1</b> Headboard	<b>2</b> Footboard	<b>3</b> Left side rail	<b>4</b> Right side rail
			
<b>5</b> Front / Back frame rail x 2	<b>6</b> Horizontal frame rail x 3	<b>7</b> Centre frame rail x 1	<b>8</b> Plastic bracket sets x 4
			
<b>9</b> Corner brackets x 4	<b>10</b> Holding blocks x 1	<b>11</b> Plastic legs x 4	<b>12</b> Bolt x 1
			
<b>13</b> Bent slats x 25 (single & double) x 30 (king)	<b>14</b> Side slat caps x 25 (single & double) x 30 (king)	<b>15</b> Centre slat caps x 13 (single & double) x 15 (king)	<b>16</b> Woven fabric x 1

## FIXINGS

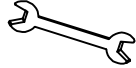
		
<b>A</b> 25mm M8 Bolt x 12	<b>B</b> 15mm M6 Bolt x 12	<b>C</b> Nuts x 2
		
<b>D</b> 30mm M6 Bolt x 6	<b>E</b> 68mm M6 Bolt x 2	
		
<b>F</b> Spring washer x 12	<b>G</b> Flat washer x 12	<b>H</b> 40mm M6 Bolt x 4
		
<b>I</b> 5mm Allen key x 1	<b>J</b> 4mm Allen key x 2	<b>K</b> Spanner x 1

# PC030A HOLLYWOOD OTTOMAN BED

## Step1:

### Attaching side rails

**A:** Position left side rail **3** adjacent to headboard **1** so that the holes in the headboard line up with the bracket on the side rail. Secure in place using 3 bolts **A**, spring washers **B**: **F** and flat washers **G** using the allen key provided.

**B:** Repeat point A for right side rail **4**.

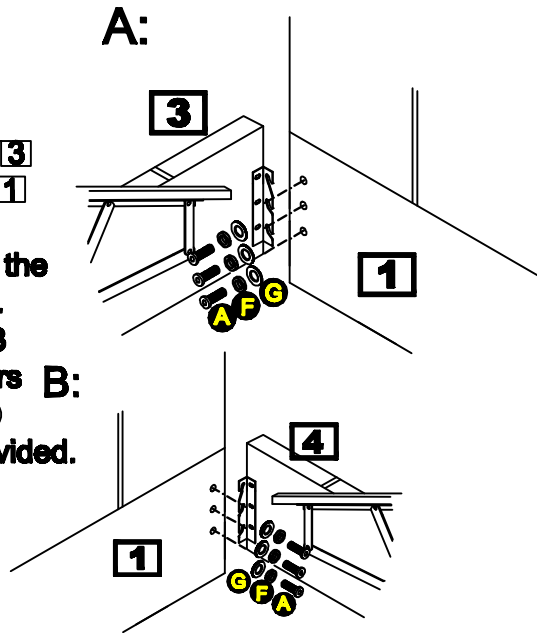

### Parts Required

- 1** Headboard
- 3** Left side rail
- 4** Right side rail
- A** 25mm M8 Bolt x 6
- F** Spring washer x 6
- G** Flat washer x 6

## Step2:

### Attaching footboard

**A:** Place footboard **2** in position at the end of the side rails **3** & **1** so the holes in the footboard line up with the brackets on the side rail.

**B:** Secure in place using 3 bolts **A**, spring washers **F** and flat washers **G** using the allen key provided.

**C:** Before tightening the bolts, please ensure the bed frame is square.

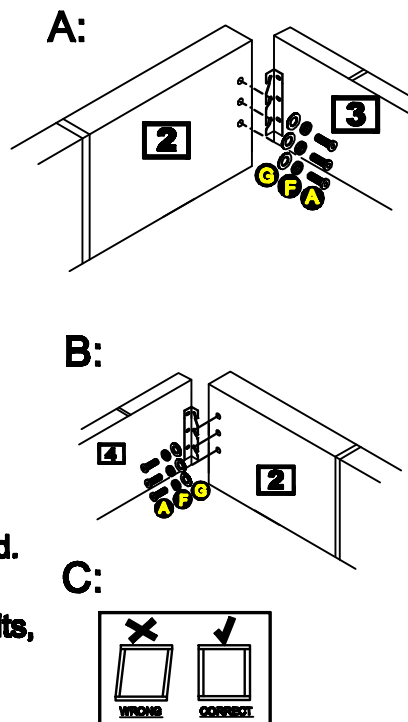

### Parts Required

- 1** Headboard
- 2** Footboard
- 3** Left side rail
- A** 25mm M8 Bolt x 6
- F** Spring washer x 6
- G** Flat washer x 6

# PC030A HOLLYWOOD OTTOMAN BED

## Step3:

Fix corner brackets

Fix corner bracket **9** in position between the left side rail **3** and headboard **1** using bolt **B**.

Repeat for other 3 corner brackets in each corner of the bed frame.

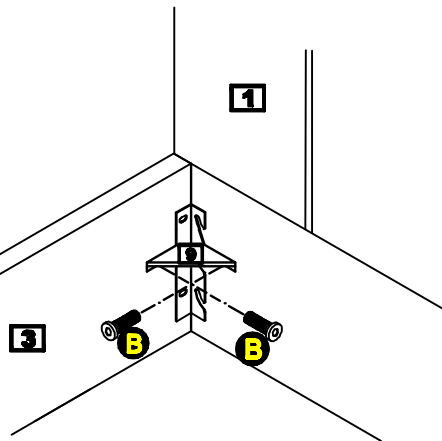

### Parts Required

- 1** Headboard
- 3** Left side rail
- 9** Corner brackets
- B** 15mm M6 Bolt x8

## Step4:

Fix holding block

Fix holding block **10** onto footboard **2** using bolt **E** and tighten using allen key.

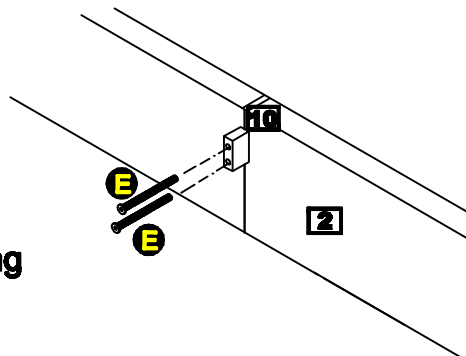

### Parts Required

- 2** Footboard
- 10** Holding blocks
- E** 68mm M6 Bolt x2

# PC030A HOLLYWOOD OTTOMAN BED

## Step5:

### Secure pneumatic arms

Before connecting the pneumatic arms, ensure the lifting mechanism is functioning correctly - it should lift up and down freely with adequate clearance on all sides.

Please ensure the pneumatic arm is in the correct orientation. The thinner section should be attached to the side rail, and the thicker part is connected to the slat frame.

### Remark

Secure the pneumatic lifting mechanisms on the side rails **3** & **4** into place by using nuts **C** as shown.

Do not overtighten the nuts.

### Parts Required

- 3** Left side rail
- 4** Right side rail
- C** Nuts x 2

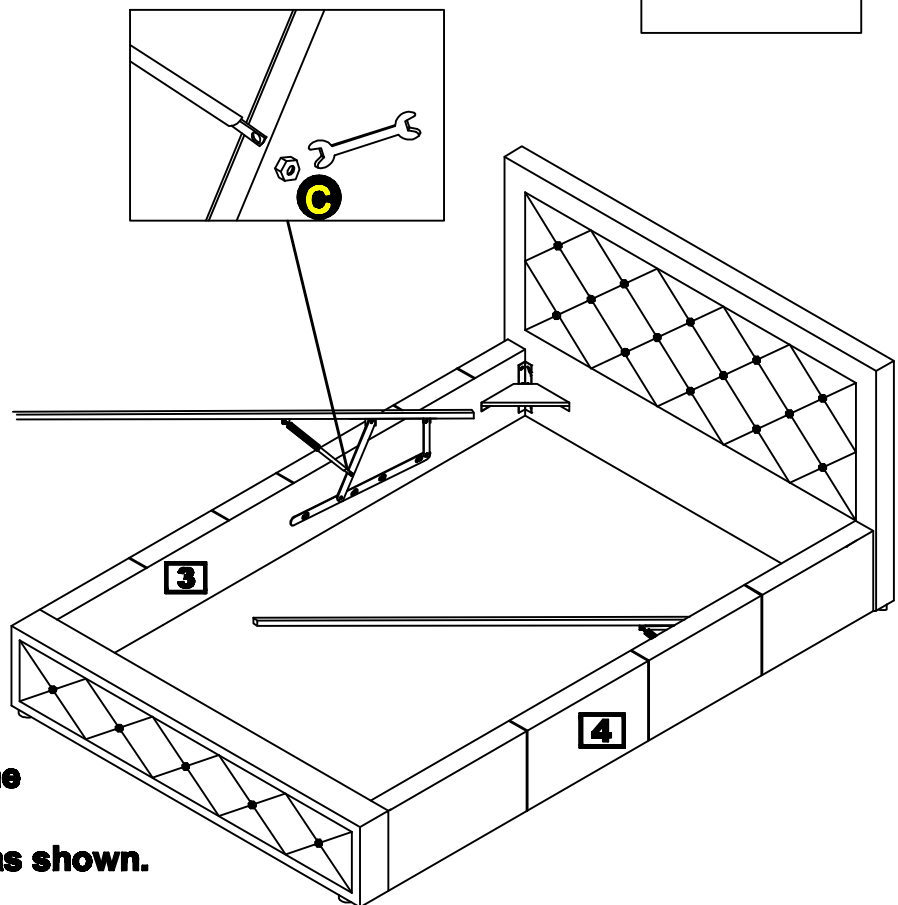

# PC030A HOLLYWOOD OTTOMAN BED

## Step6:

### Assemble slat frame

**A:** Fix the front/back frame rails **5** to the side support rails which are already attached to the lifting mechanism with plastic brackets **8**

**A:**

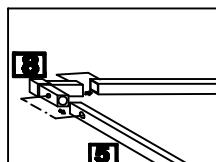

**B:**

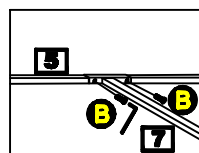

### Parts Required

- 5** Front / Back frame rail
- 7** Centre frame rail
- 8** Plastic bracket sets
- B** 15mm M6 Bolt x4

Repeat on all four corners.

**B:** Fix centre frame rail **7** to front / back frame rails **5** using bolt **B** and tighten with allen key provided.

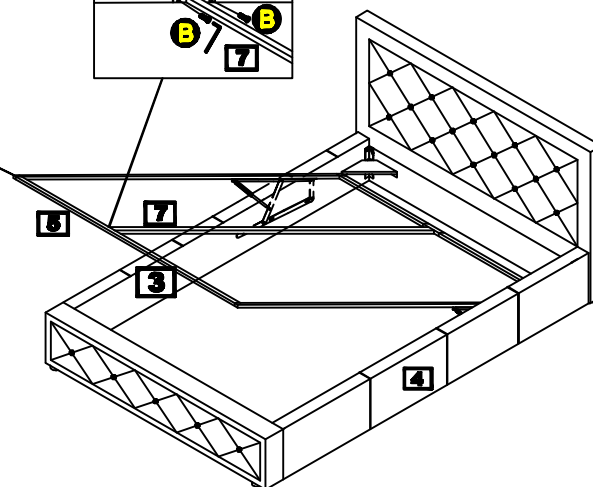

## Step7:

### Attach the horizontal supports

Fix the horizontal support rails **6** on the bottom of the lifting mechanism rail using bolts **D** with the allen key provided.

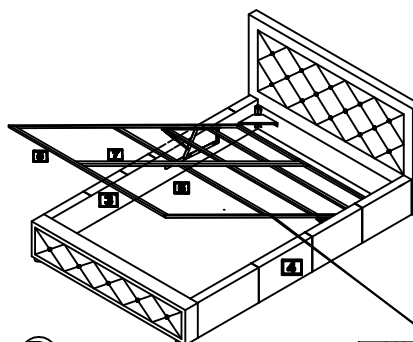

### Parts Required

- 6** Horizontal frame rail
- D** 30mm M6 Bolt x 6

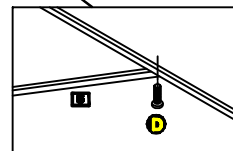

# PC030A HOLLYWOOD OTTOMAN BED

## Step8:

**A: Attach woven fabric**  
Turn bed on its side and attach woven fabric **16** to base.

**B: Attach adjustable legs**  
Whilst bed is on its side, attach plastic legs **11** using bolt **H** to the base and tighten using allen key provided.

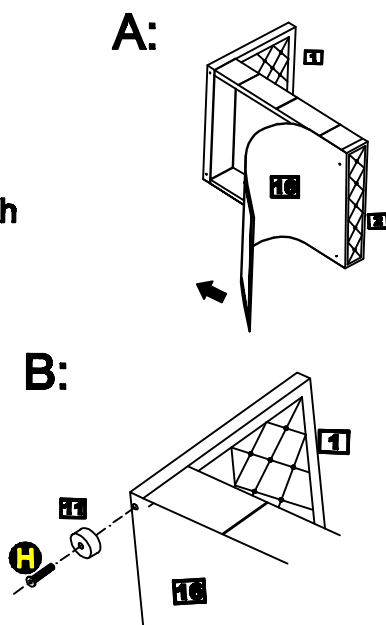

### Parts Required

- 11** Adjustable legs
- 16** Woven fabric
- H** 40mm M6 Bolt x 4

## Step9:

**A: Attach centre slat caps **15** and side slat caps **14** to each slat **13** as shown.**

Attach the slats to the slat frame by firmly pushing into place on the slat frame.

**B: Attach belt **12** to the metal frame by loop-on method as shown. pull tight after loop-on.**

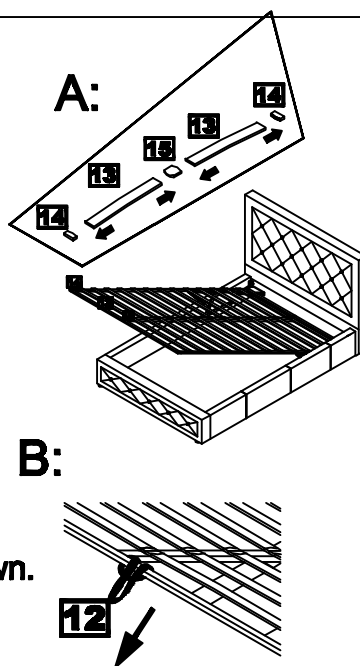

### Parts Required

- 12** Belt
- 13** Bent slats
- 14** Side slat caps
- 15** Centre slat caps