

# LIGHT OAK EFFECT VENEER LISBON 3 DOOR WARDROBE ASSEMBLY INSTRUCTIONS



## **IMPORTANT FOR DOMESTIC USE ONLY PLEASE READ BEFORE YOU CONTINUE FURTHER**

THE PRODUCT YOU HAVE PURCHASED WILL GIVE YOU MANY YEARS OF SERVICE IF YOU FOLLOW THE GUIDELINES FOR ITS SAFE ASSEMBLY AND PERIODIC MAINTENANCE AND CLEANING.

ASSEMBLE ON A SOFT CLEAN SURFACE.

DO NOT USE ANY TOOLS OTHER THAN THOSE SHOWN.

ANY SPANNERS OR ALLEN KEYS REQUIRED ARE INCLUDED WITH THE FITTINGS KIT.

DO NOT FOR ANY REASON USE A POWER TOOL TO ASSEMBLE THIS PRODUCT. ITS USE WILL INVALIDATE ANY CLAIM YOU MAY HAVE AND COULD MAKE THIS PRODUCT UNSAFE.

DEPENDING ON THE AMOUNT OF USE THIS PRODUCT RECEIVES IT MAY BE NECESSARY TO TIGHTEN UP THE FIXINGS FROM TIME TO TIME. THIS IS COMPLETELY NORMAL FOR ANY FLAT PACK FURNITURE. DO NOT OVERTIGHTEN FIXING.

FOR CLEANING, YOU MAY USE A DAMP CLOTH (NOT WET) DO NOT USE POLISH, DÉTERGENT OR CHEMICAL CLEANERS.



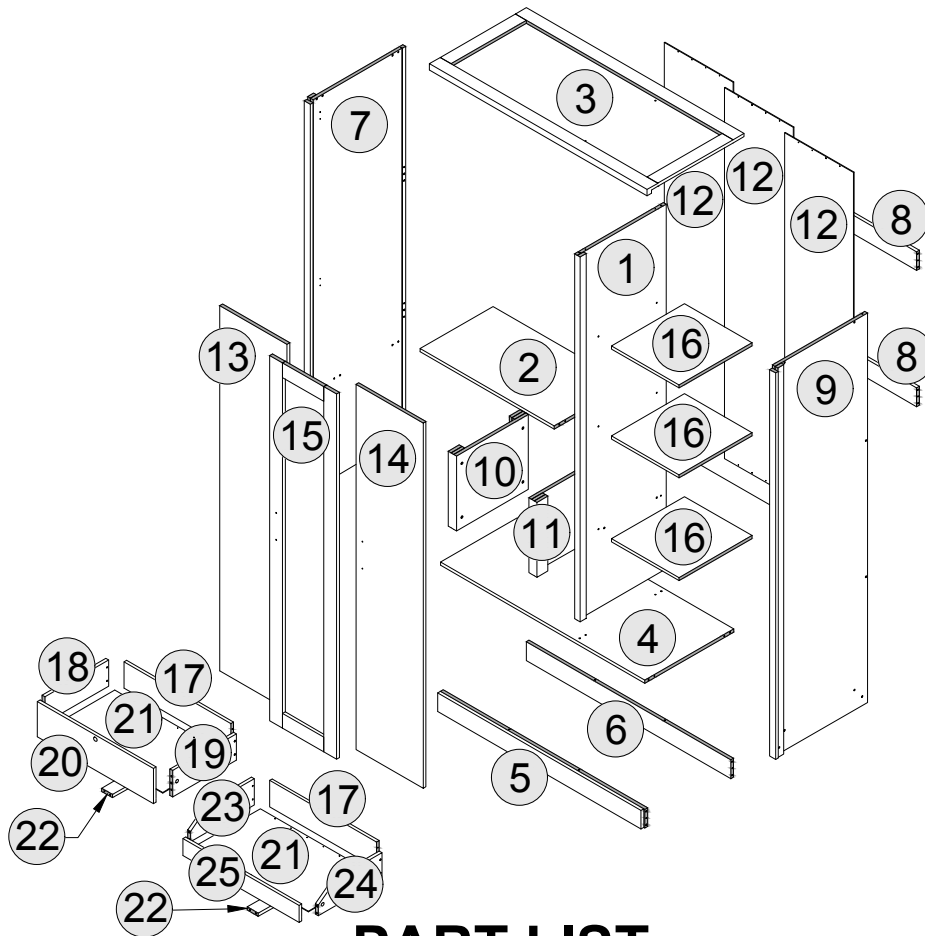









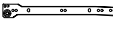













THE SURFACE OF THIS ITEM IS NOT HEAT RESISTANT. ALWAYS USE A PLACE MAT UNDER HOT OR COLD ITEMS TO PREVENT MARKING.

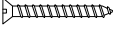

## PART LIST

Part Number	Part Code	Part Description	Quantity	Carton
1	S100-101-055-EU2-01	Inner Side Panel	1	2/4
2	S100-101-055-EU2-02	Centre Shelf	1	2/4
3	S100-101-055-EU2-03	Top Panel	1	3/4
4	S100-101-055-EU2-04	Base Panel	1	3/4
5	S100-101-055-EU2-05	Base Front Apron	1	3/4
6	S100-101-055-EU2-06	Base Back Apron	1	3/4
7	S100-101-055-EU2-07	Left Side Panel	1	1/4
8	S100-101-055-EU2-08	Back Crossbars	2	3/4
9	S100-101-055-EU2-09	Right Side Panel	1	1/4
10	S100-101-055-EU2-10	Inner Side Frame 1	1	3/4
11	S100-101-055-EU2-11	Inner Side Frame 2	1	3/4
12	S100-101-055-EU2-12	Back Panel	3	4/4
13	S100-101-055-EU2-13	Door Panel - Left	1	4/4
14	S100-101-055-EU2-14	Door Panel - Right	1	4/4
15	S100-101-055-EU2-15	Mirrored Door	1	4/4
16	S100-101-055-EU2-16	Shelf Panel	3	2/4
17	S100-101-055-EU2-17	Drawer Back	2	2/4
18	S100-101-055-EU2-18	Drawer Side - Left (Large)	1	2/4
19	S100-101-055-EU2-19	Drawer Side - Right (Large)	1	2/4
20	S100-101-055-EU2-20	Drawer Front - (Large)	1	2/4
21	S100-101-055-EU2-21	Drawer Base	2	2/4
22	S100-101-055-EU2-22	Drawer Bottom Support Rail	2	2/4
23	S100-101-055-EU2-23	Drawer Side - Left (Small)	1	2/4
24	S100-101-055-EU2-24	Drawer Side - Right (Small)	1	2/4
25	S100-101-055-EU2-25	Drawer Front - (Small)	1	2/4

## HARDWARE LIST

A		DOWEL 6 X 30MM	46 PCS	O		MIRRORED DOOR HINGES 5/8	3 PCS
B		BOLT M6 X 50MM	18 PCS	P		DRAWER RUNNER A - L/R	4 PCS
C		BOLT M7 X 60MM	2 PCS	Q		DRAWER RUNNER B - L/R	4 PCS
D		SCREW M3.5 X 16MM	37 PCS	R		SCREW M4 X 30MM	4 PCS
E		TACK	36 PCS	S		HANDLE SCREW 19MM	6 PCS
F		SCREW M4 X 38MM	8 PCS	T		LOCK	1 SET
G		HANDLE	3 PCS	U		SCREW M3.5 X 12MM	20 PCS
H		TAPPING SCREW M8 X 12MM	18 PCS	V		CAM BOLT + CAM NUT	4 SETS
I		HANGING RAIL SUPPORT	2 PCS	W		PLASTIC FOOT	5 PCS
J		HANGING RAIL	1 PC	X		PLASTIC FOOT FRONT	1 PC
K		PLASTIC H STRIP	2 PCS	Y		SCREW M4 X 50MM	12 PCS
L		SHELF SUPPORT	12 PCS	Z		ALLEN KEY	1 PC
M		PVC STOPPER	1 PC	Z1		ANTI - TIP STRAP	2 PCS
N		RIGHT/LEFT DOOR HINGES 7/8	6 PCS	Z2		SCREW M4 X 16MM	2 PCS

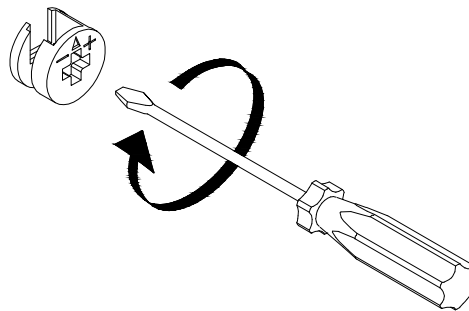

(SCREWDRIVER NOT PROVIDED)

USE A FLAT HEAD SCREWDRIVER TO TIGHTEN THE CAM NUTS. A QUARTER TURN CLOCKWISE IS ALL THAT IS NEEDED.

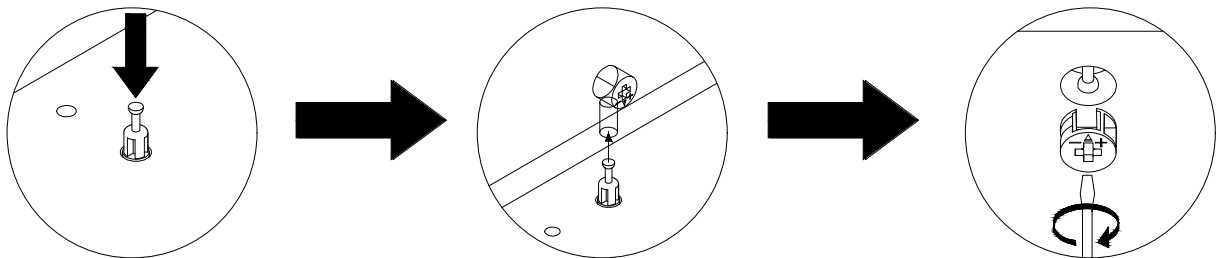

STEP 1 - PUSH CAM BOLT INTO INSERT

STEP 2 - ALIGN THE CAM BOLT WITH THE HOLE AND PUSH TOGETHER UNTIL FLUSH. ( MAKE SURE THE ARROW OF THE CAM LOCK IS POINTING TOWARD ON THE EDGE OF THE PANEL.)

STEP 3 - THE HEAD OF THE BOLT GOES INTO THE WIDE MOUTH OF THE CAM LOCK. YOU THEN TURN THE LOCK SO THE NARROW PART CLOSES OVER THE BOLT.

# STEP 1

**PARTS REQUIRED**

7 - LEFT SIDE PANEL x1

9 - RIGHT SIDE PANEL x1

**HARDWARE REQUIRED**

I  01

L  06

U  02

**TOOLS REQUIRED**

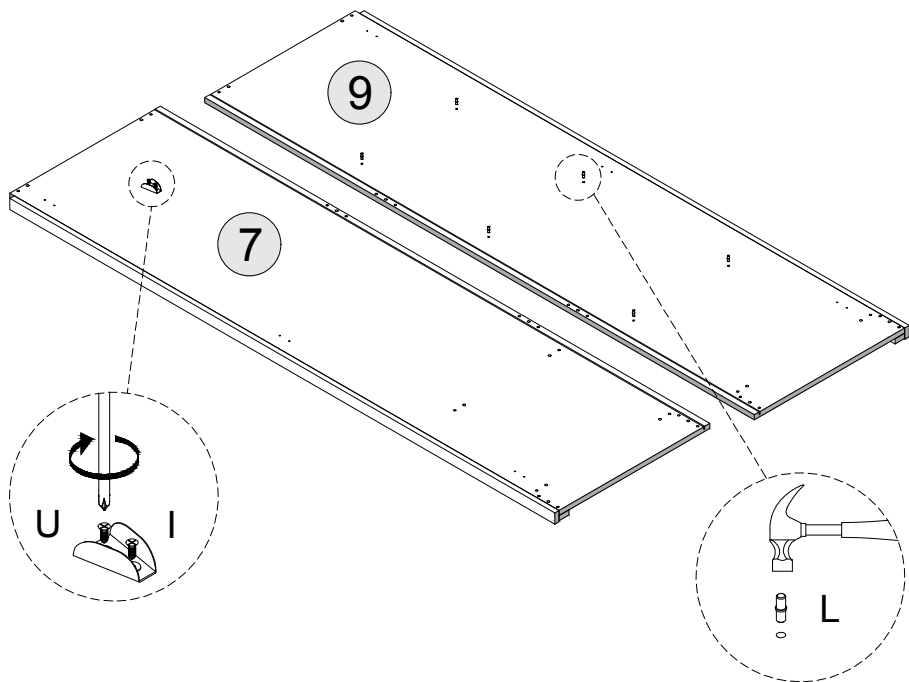
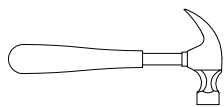
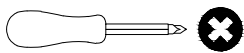

# STEP 2

**PARTS REQUIRED**

1 - INNER SIDE PANEL x1

**HARDWARE REQUIRED**

A  04

I  01

L  06

U  02

**TOOLS REQUIRED**

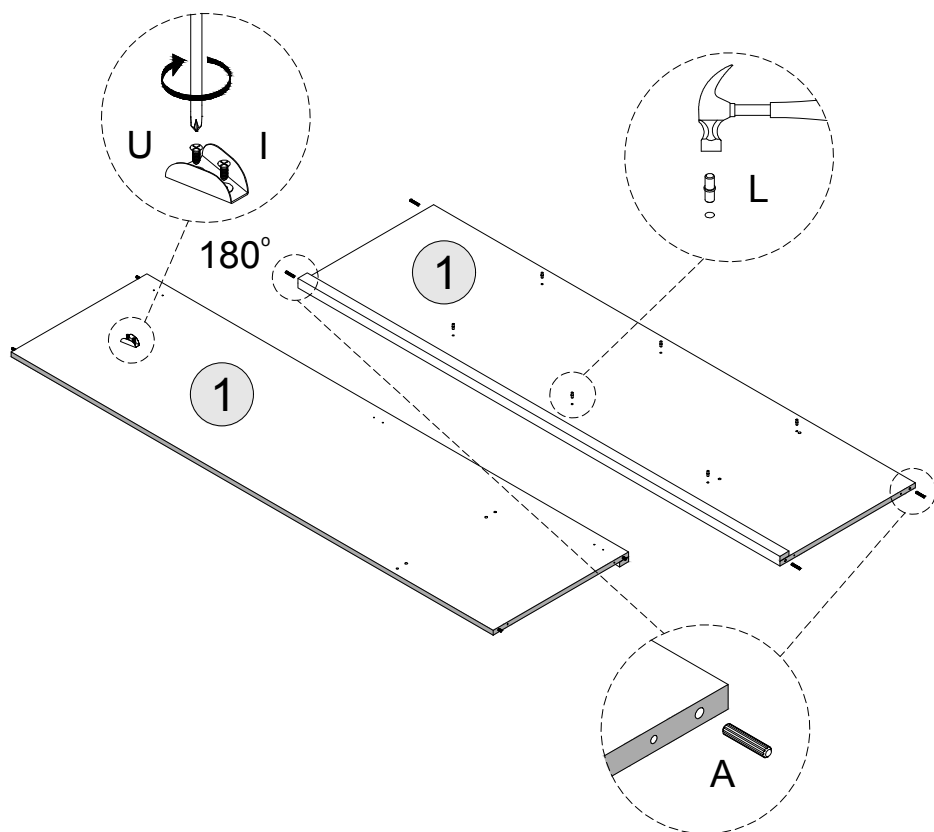
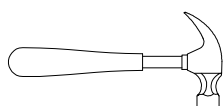
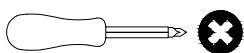

# STEP 3

**PARTS REQUIRED**

2 - CENTRE SHELF	x1
4 - BASE PANEL	x1
5 - BASE FRONT APRON	x1
6 - BASE BACK APRON	x1
8 - BACK CROSSBARS	x2

**HARDWARE REQUIRED**

A		28
---	---	----

**TOOLS REQUIRED**

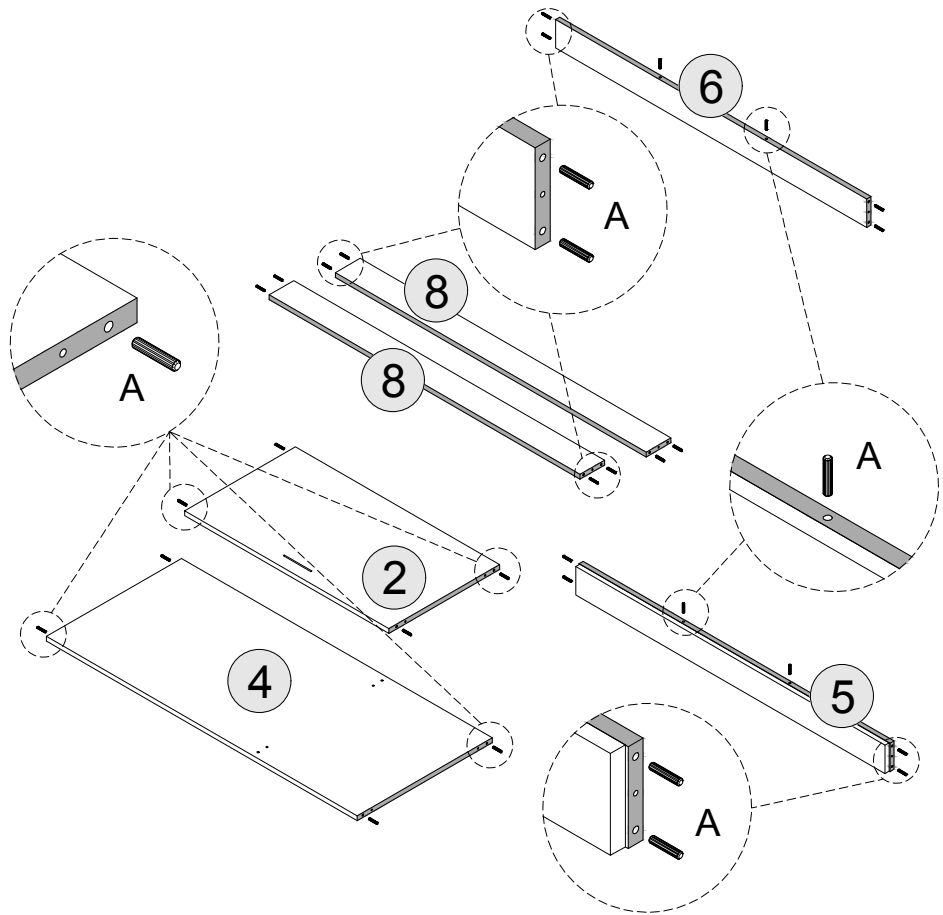
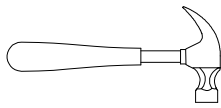

# STEP 4

**PARTS REQUIRED**

3 - TOP PANEL	x1
10 - INNER SIDE FRAME 1	x1
11 - INNER SIDE FRAME 2	x1

**HARDWARE REQUIRED**

A		04
---	---	----

D		01
---	---	----

M		01
---	---	----

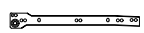
P		04
---	---	----

U		16
---	---	----

**TOOLS REQUIRED**

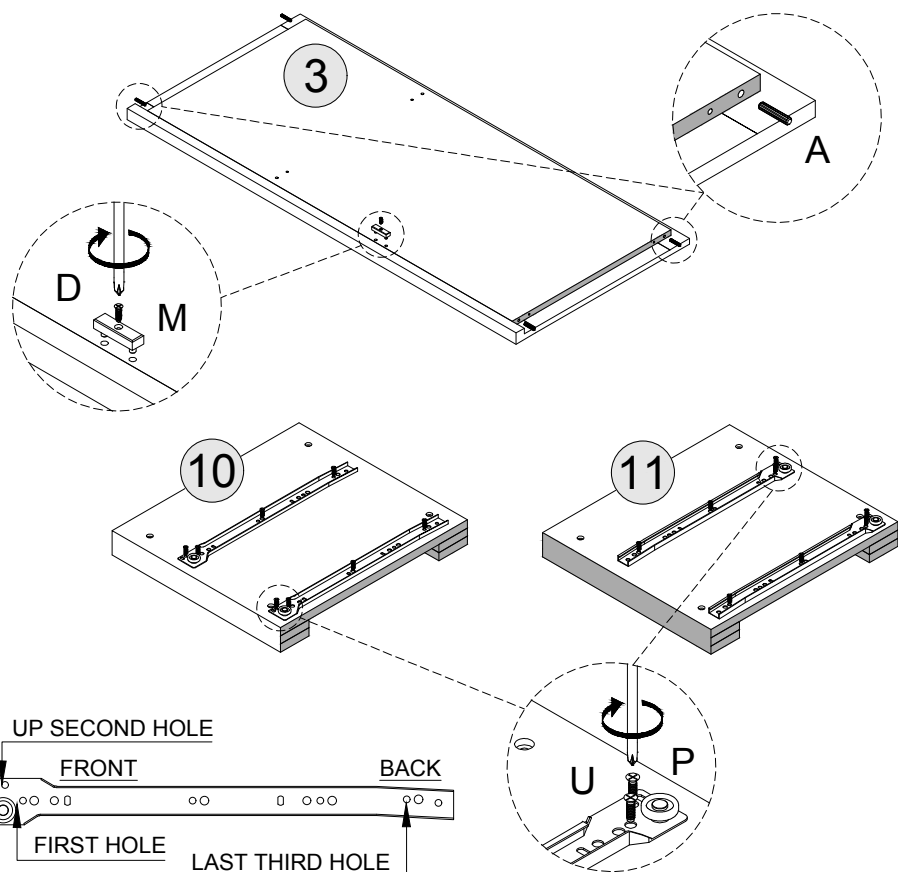
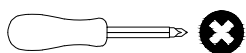

## STEP 5

**PARTS REQUIRED**

1 - INNER SIDE PANEL x1

2 - CENTRE SHELF x1

**HARDWARE REQUIRED**

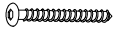
B  02

**TOOLS REQUIRED**

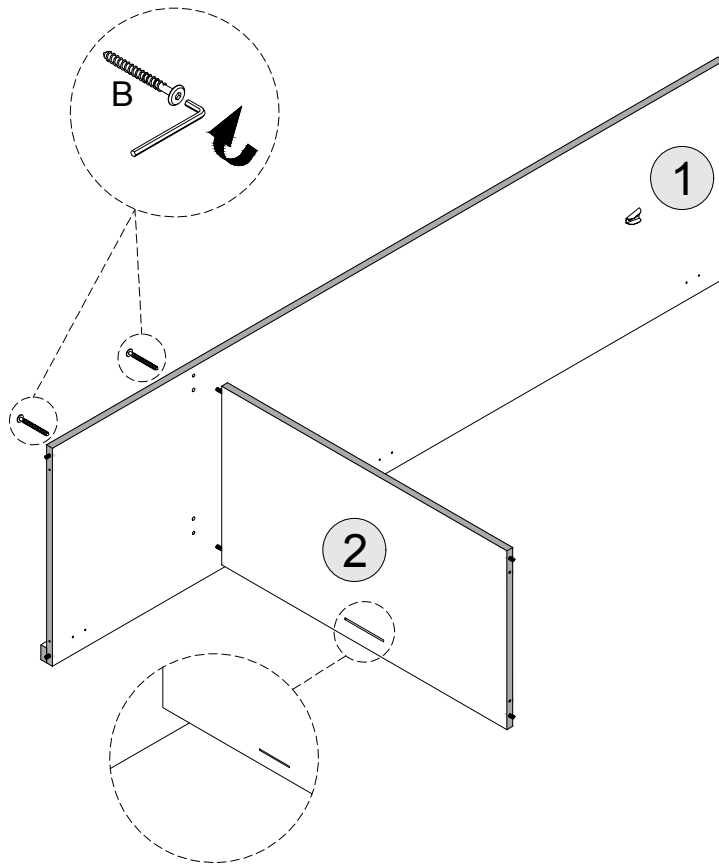

## STEP 6

**PARTS REQUIRED**

3 - TOP PANEL x1

4 - BASE PANEL x1

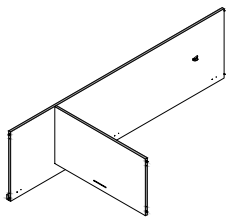

**HARDWARE REQUIRED**

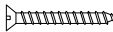
Y  04

**TOOLS REQUIRED**

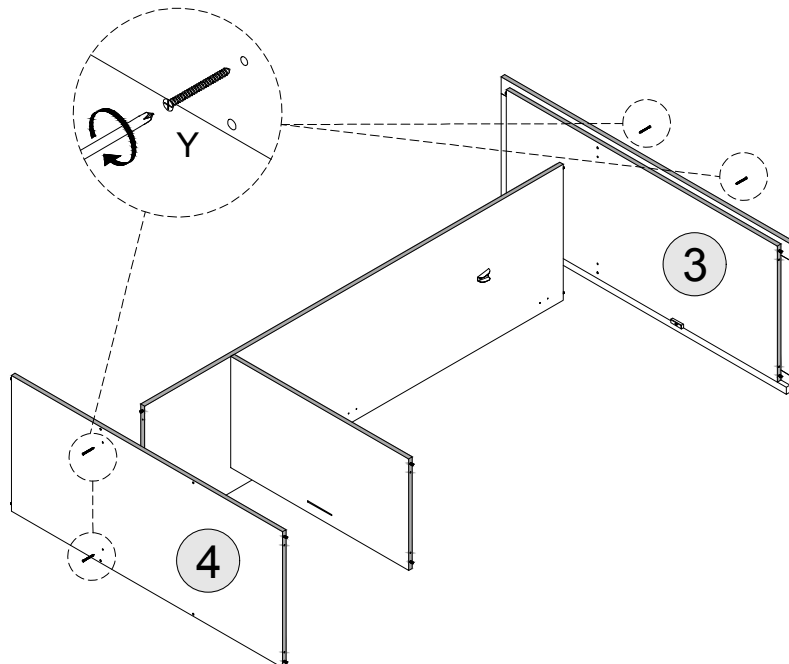
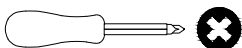

# STEP 7

**PARTS REQUIRED**

- 5 - BASE FRONT APRON x1
- 6 - BASE BACK APRON x1
- 7 - LEFT SIDE PANEL x1

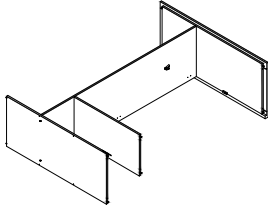

**HARDWARE REQUIRED**

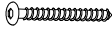
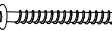
- B  07
- C  01

**TOOLS REQUIRED**

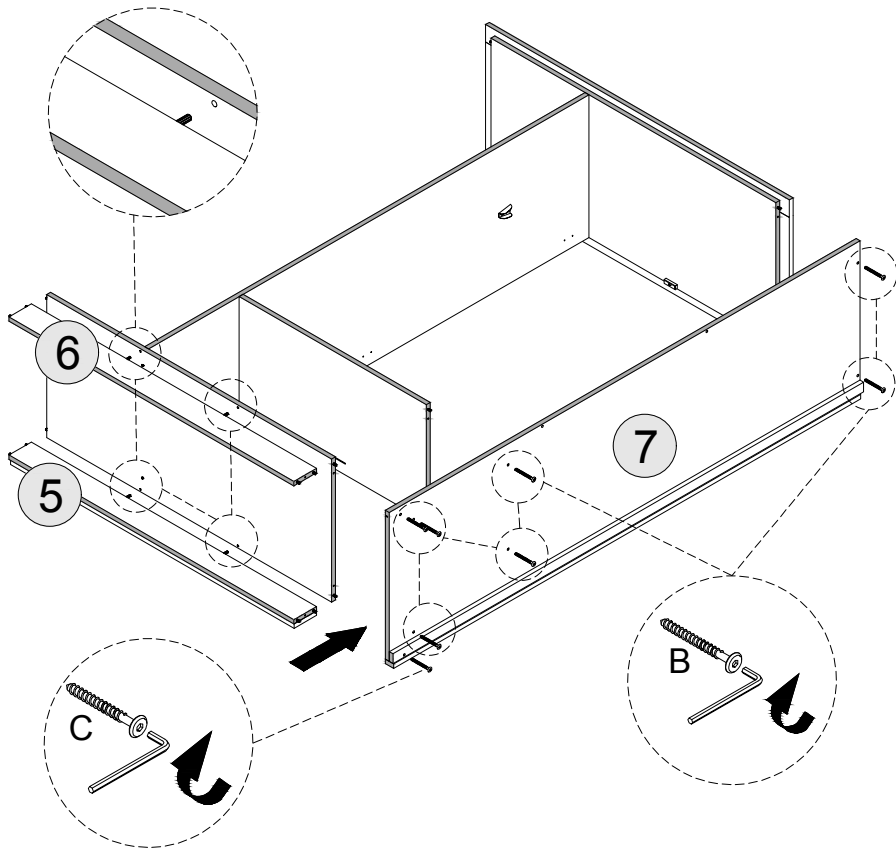

# STEP 8

**PARTS REQUIRED**

- 8 - BACK CROSSBARS x2
- 9 - RIGHT SIDE PANEL x1

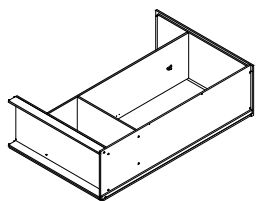

**HARDWARE REQUIRED**

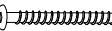
- B  09
- C  01

**TOOLS REQUIRED**

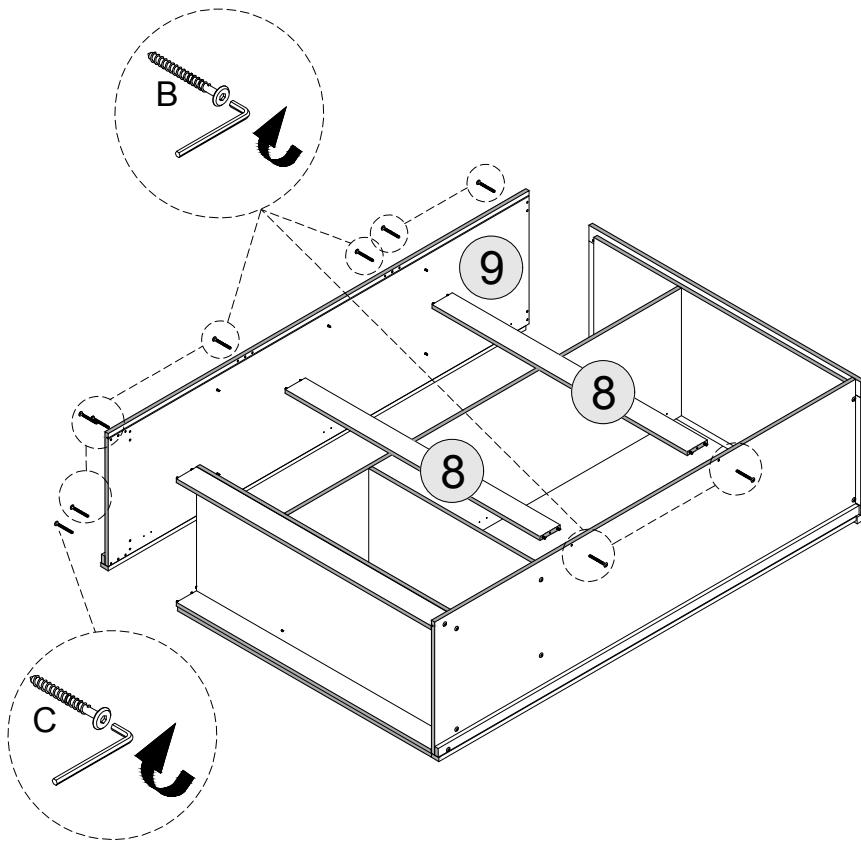

# STEP 9

**PARTS REQUIRED**

- 10 - INNER SIDE PANEL x1
- 11 - INNER SIDE PANEL x1

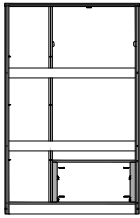

**HARDWARE REQUIRED**

- Y 08

**TOOLS REQUIRED**

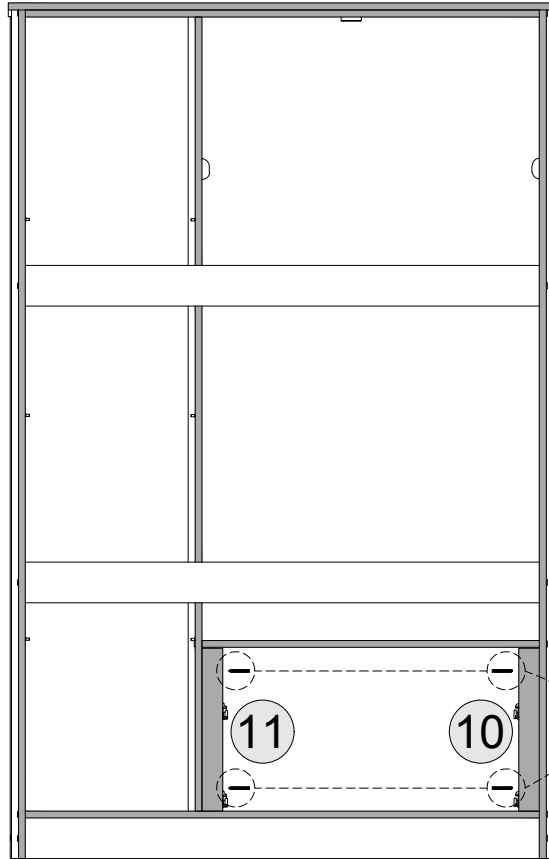
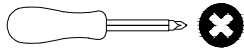

**BACK SIDE VIEW**

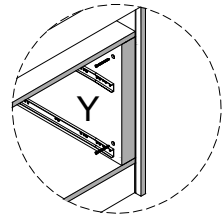

**BACK SIDE VIEW**

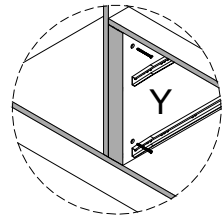

**SIDE VIEW**

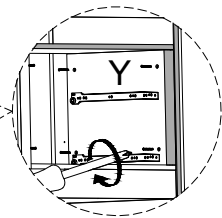

# STEP 10

**PARTS REQUIRED**

- 12 - BACK PANEL x3

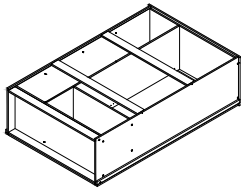

**HARDWARE REQUIRED**

- D 06
- E 24
- K 02
- W 05
- X 01

**TOOLS REQUIRED**

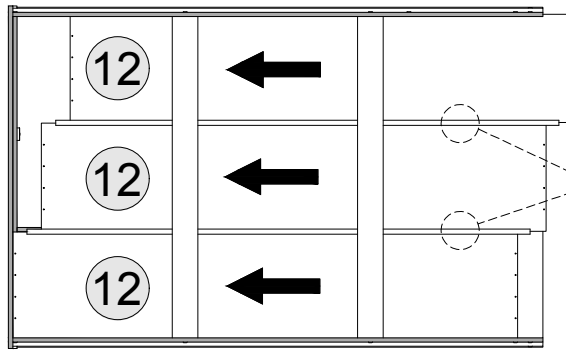
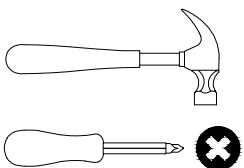

PLEASE INSERT THE BACK PANEL INTO THE UNIT

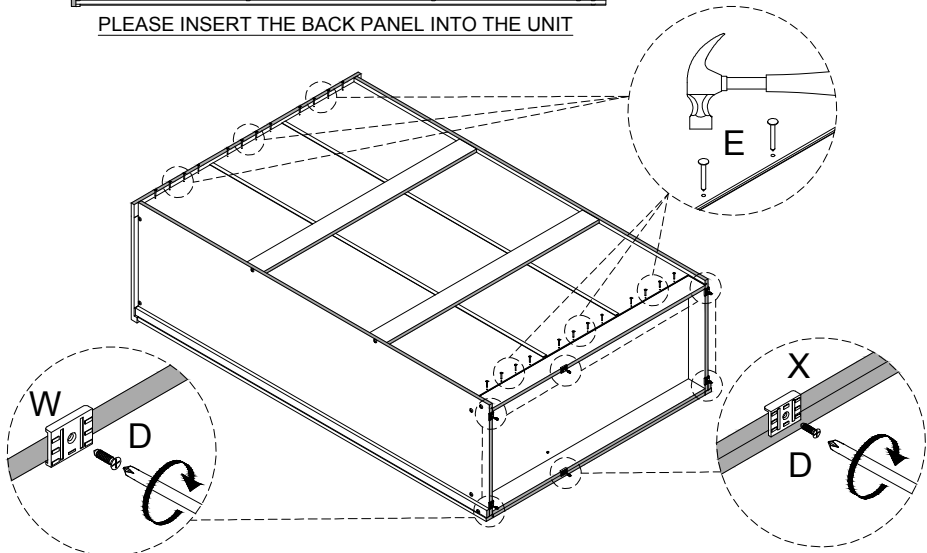
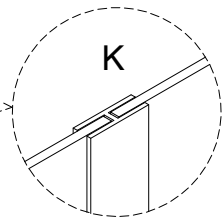







# STEP 11

**PARTS REQUIRED**

13 - DOOR PANEL - LEFT	x1
14 - DOOR PANEL - RIGHT	x1
15 - MIRRORED DOOR	x1

**HARDWARE REQUIRED**

D		18
G		03
N		06
O		03
S		06

**TOOLS REQUIRED**

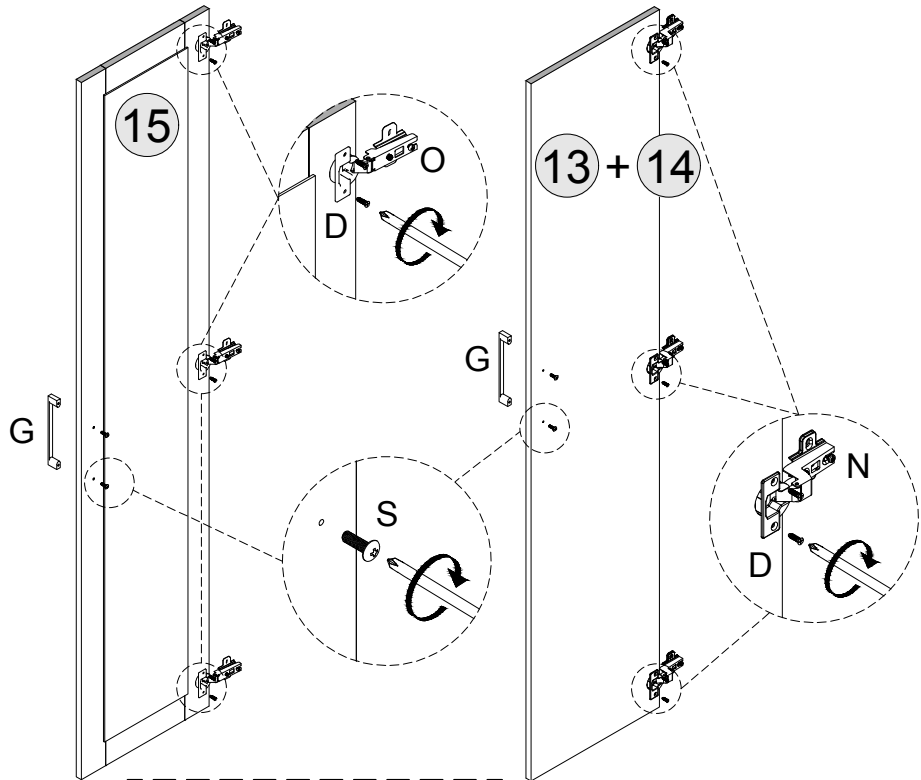
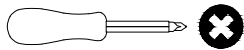

PLEASE MAKE SURE THE MIRRORED DOOR HINGES ( HARDWARE O ) ARE ATTACHED TO THE MIRRORED DOOR ( PART 15 )



# STEP 12

**PARTS REQUIRED**

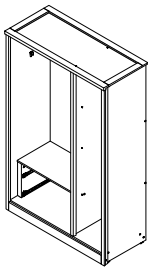
13 - DOOR PANEL - LEFT	x1
------------------------	----



**HARDWARE REQUIRED**

H		06
J		01

**TOOLS REQUIRED**

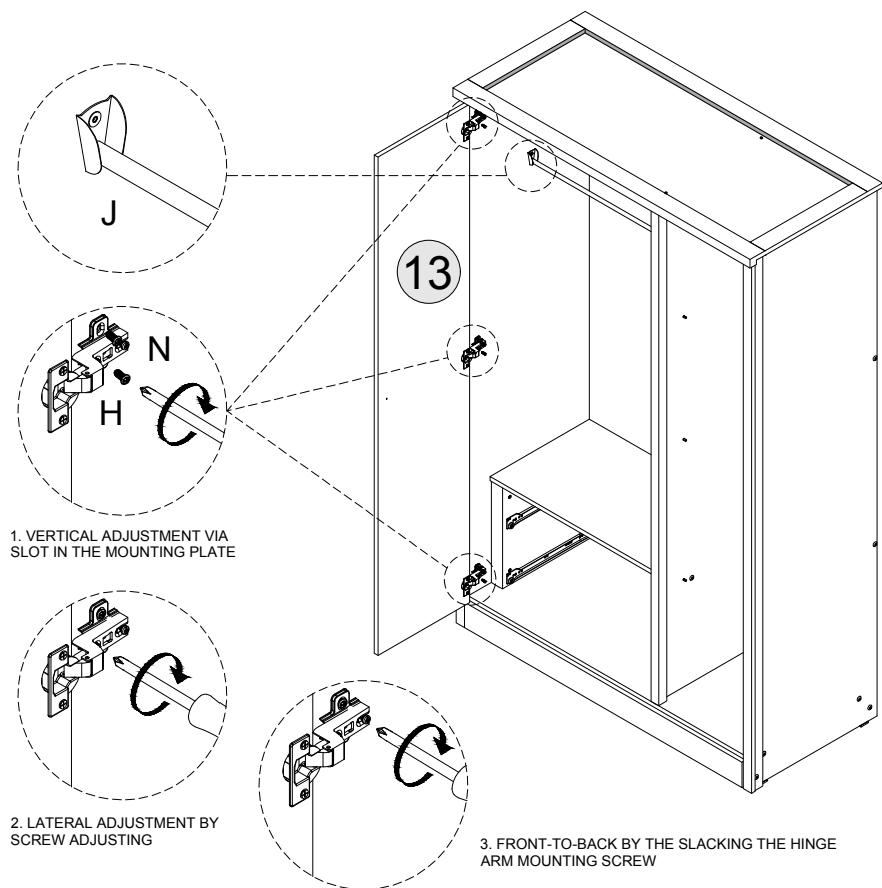
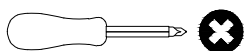

1. VERTICAL ADJUSTMENT VIA SLOT IN THE MOUNTING PLATE

2. LATERAL ADJUSTMENT BY SCREW ADJUSTING

3. FRONT-TO-BACK BY THE SLACKING THE HINGE ARM MOUNTING SCREW

YOU SHOULD RE-ADJUST SCREWS AS SHOWN TO ALIGN DOOR ONCE HINGES HAVE BEEN ATTACHED.

# STEP 13

**PARTS REQUIRED**

- 14 - DOOR PANEL - RIGHT x1
- 15 - MIRRORED DOOR x1
- 16 - SHELF PANEL x3

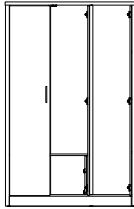

**HARDWARE REQUIRED**

- H  12

**TOOLS REQUIRED**

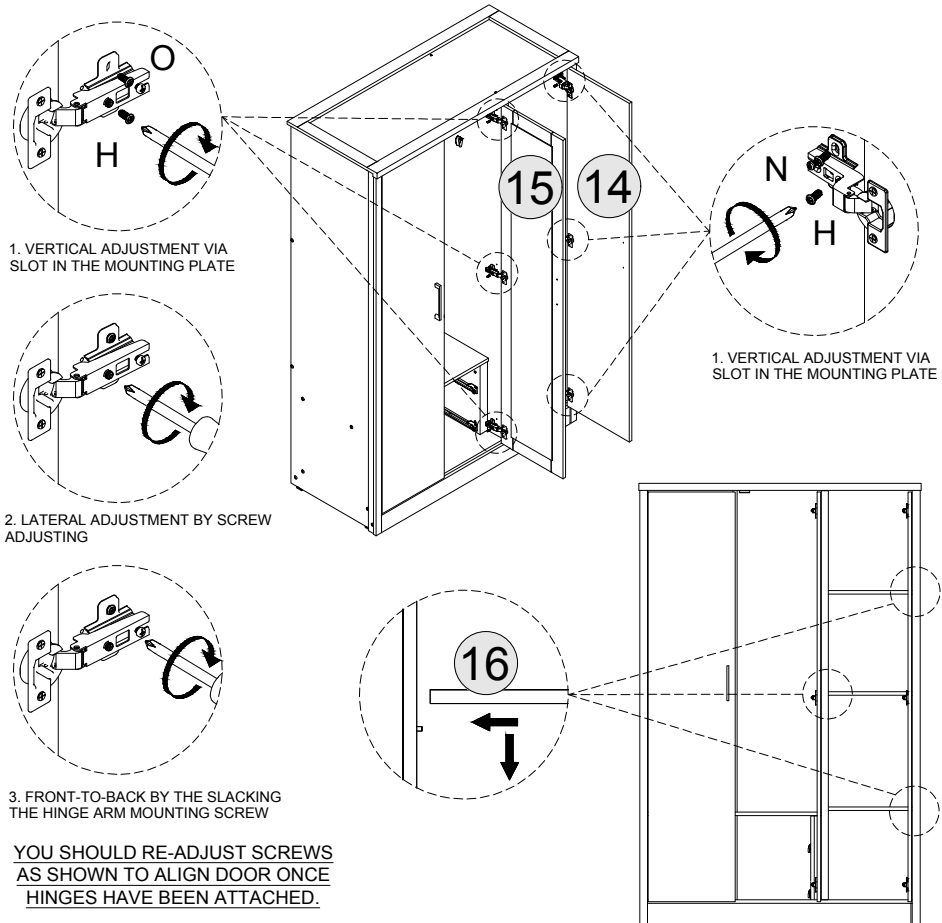
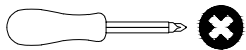



# STEP 14

**PARTS REQUIRED**

- 17 - DRAWER BACK x1
- 18 - DRAWER SIDE-LEFT(LARGE) x1
- 19 - DRAWER SIDE-RIGHT(LARGE) x1
- 20 - DRAWER FRONT-(LARGE)x1

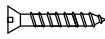
**HARDWARE REQUIRED**

- A  04
- F  04
- V  02

**TOOLS REQUIRED**

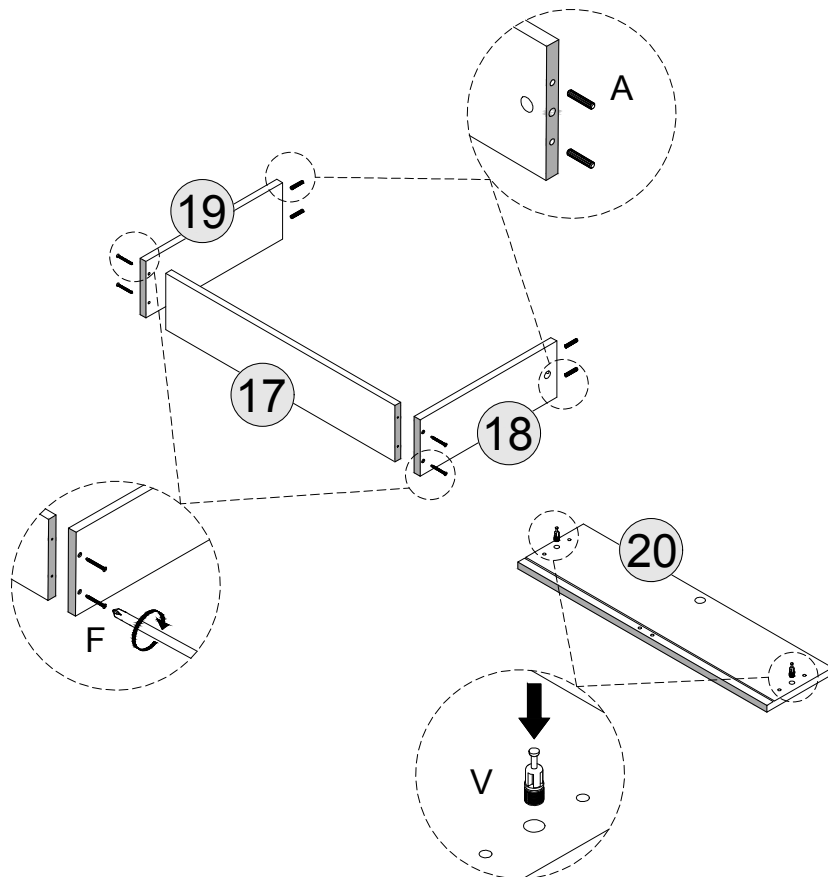
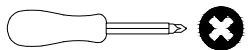

# STEP 15

**PARTS REQUIRED**

21 - DRAWER BASE x1

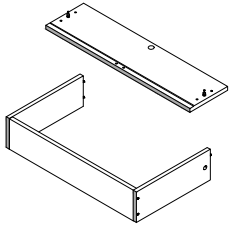

**HARDWARE REQUIRED**

E  06

T  01

V  02

**TOOLS REQUIRED**

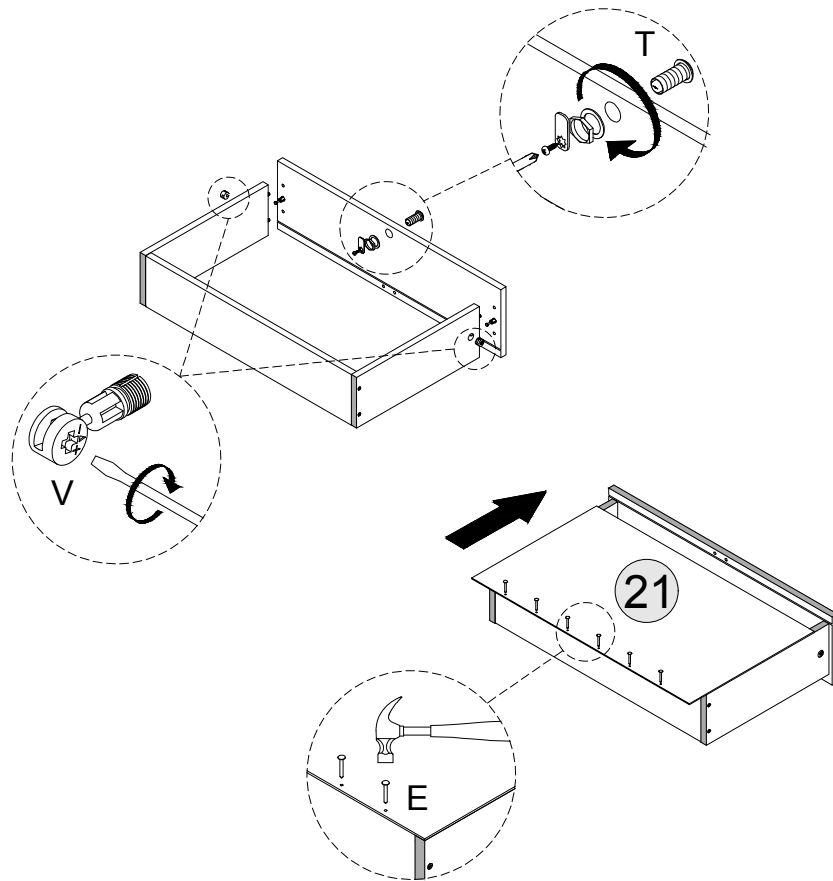
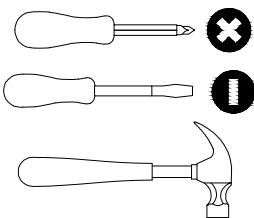

# STEP 16

**PARTS REQUIRED**

22 - DRAWER BOTTOM SUPPORT RAIL x1

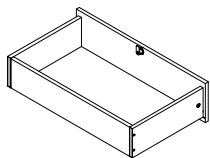

**HARDWARE REQUIRED**

A  02

D  06

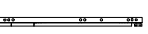
Q  02

R  02

**TOOLS REQUIRED**

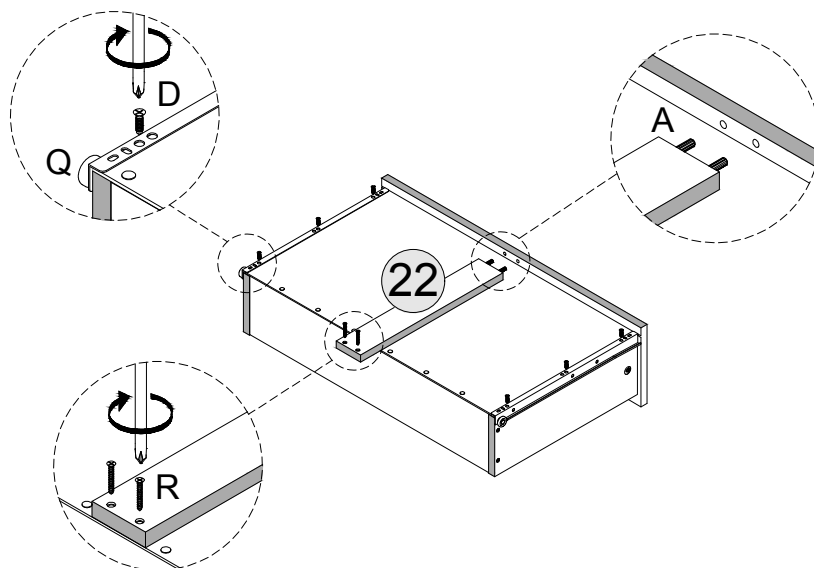
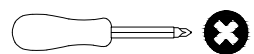



# STEP 17

**PARTS REQUIRED**

- 17 - DRAWER BACK x1
- 23 - DRAWER SIDE-LEFT(SMALL) x1
- 24 - DRAWER SIDE-RIGHT(SMALL) x1
- 25 - DRAWER FRONT-(SMALL) x1

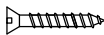
**HARDWARE REQUIRED**

- A  02
- F  04
- V  02

**TOOLS REQUIRED**

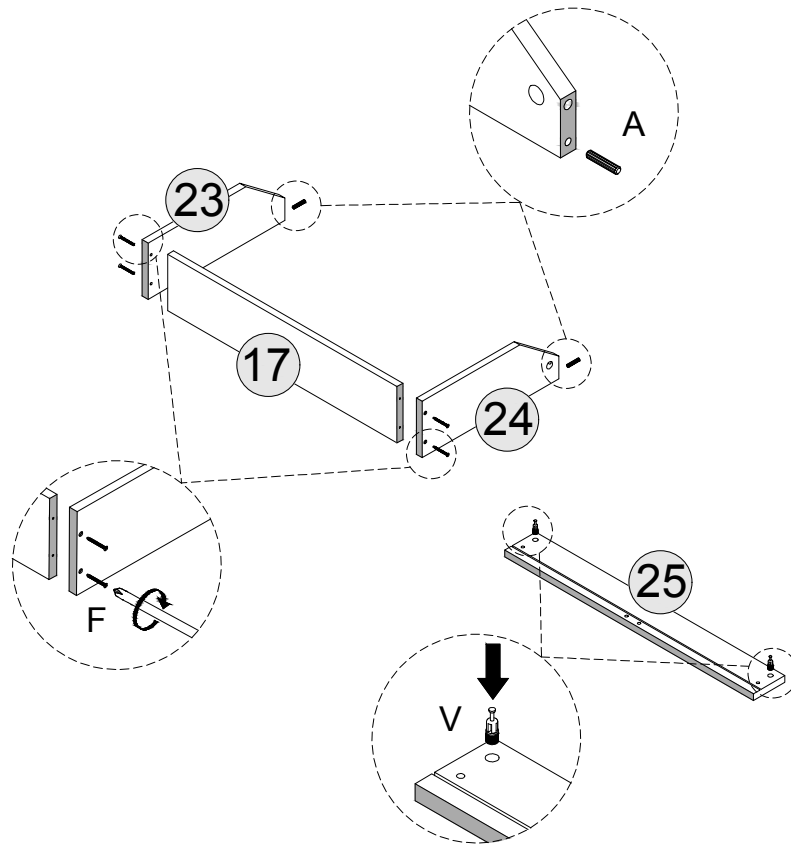
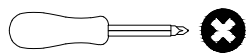



# STEP 18

**PARTS REQUIRED**

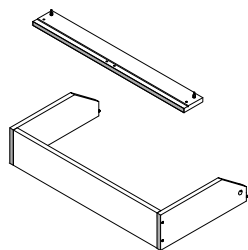
- 21 - DRAWER BASE x1



**HARDWARE REQUIRED**

- E  06
- V  02

**TOOLS REQUIRED**

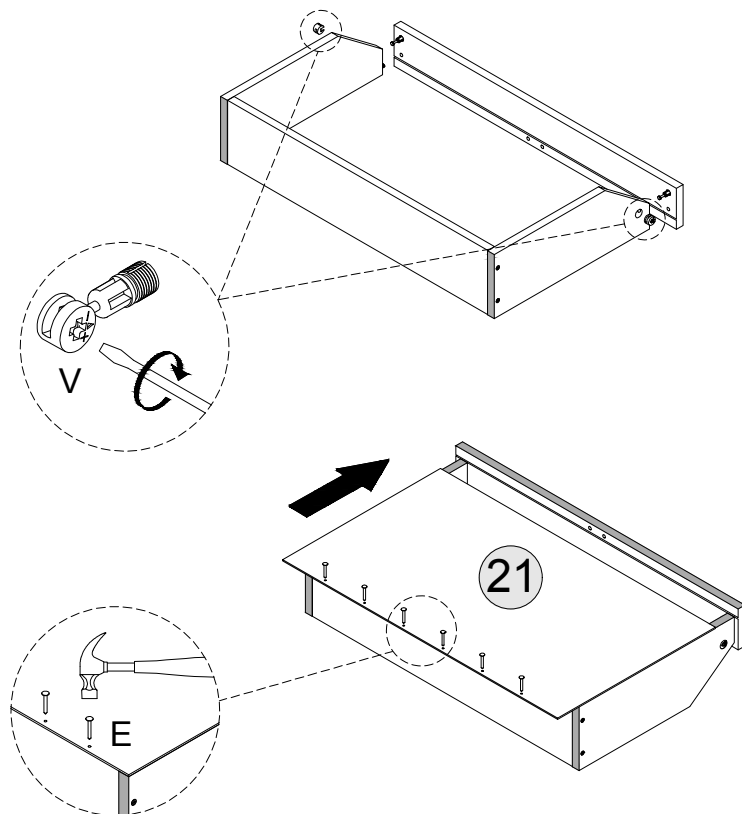
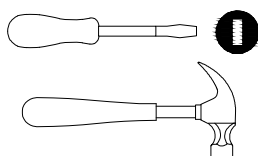

# STEP 19

**PARTS REQUIRED**

22 -DRAWER BOTTOM SUPPORT RAIL x1

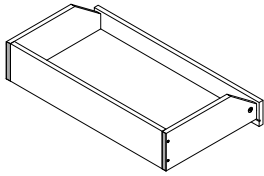

**HARDWARE REQUIRED**

A  02

D  06

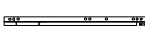
Q  02

R  02

**TOOLS REQUIRED**

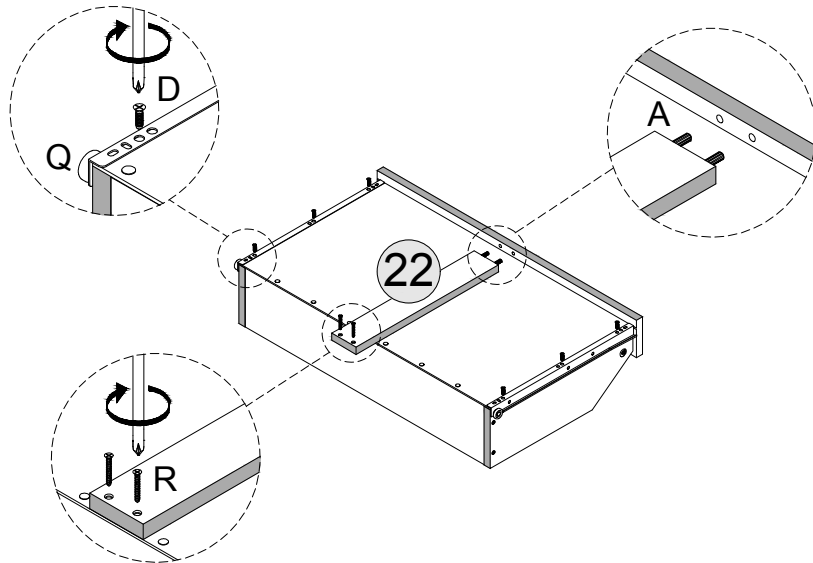
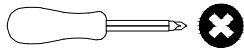

# STEP 20

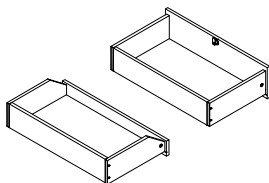
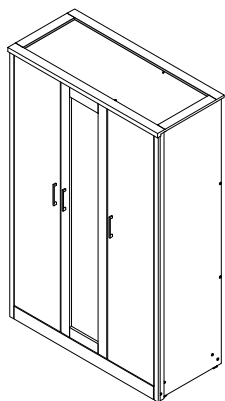

**PARTS REQUIRED**

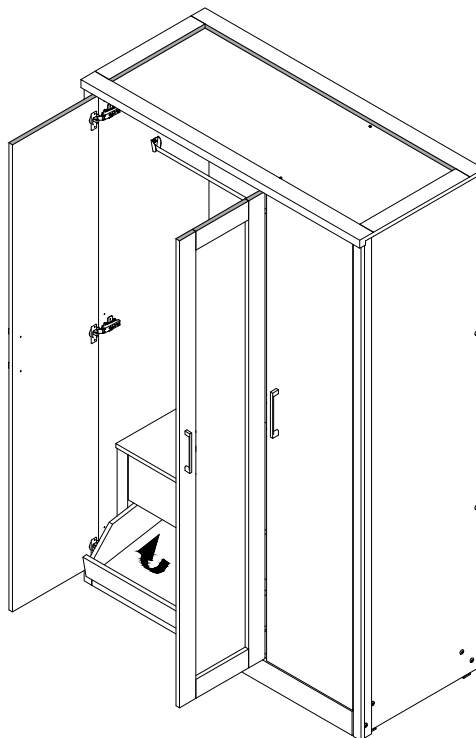

**HARDWARE REQUIRED**

**TOOLS REQUIRED**

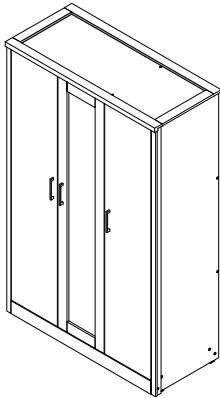

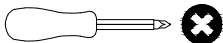
**STEP 21**PART REQUIREDHARDWARE REQUIREDZ1  02Z2  02TOOLS REQUIRED**WARNING**

Serious or fatal injuries can occur from furniture tipping over. To prevent the furniture from tipping over we recommend that it is permanently fixed to the wall.

Wall fixings are not supplied with this product as different wall materials require different types of fixing devices. Please make sure you use fixings suitable for the walls in your home.

