

Assembly Instructions: Havana Robe 3 Doors: March, 2020 - 008810

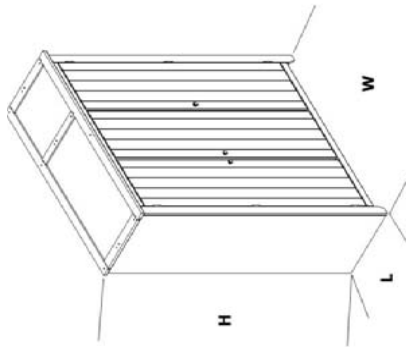

Assembled Dimensions
L Length : 57cm
W Width : 149cm
H Head Height : 188cm

PLEASE NOTE : CHECK ALL PARTS BEFORE ASSEMBLING ONCE ASSEMBLED THIS ITEM CANNOT BE RETURNED UNDER THE APPROVAL GUARANTEE THIS PRODUCT IS BUILT VERTICALLY - PLEASE BUILD WHERE IT WILL BE USED.

Follow Me

- FIRST: Check that the assembled product size will fit in its required location. Take into account ceiling height clearance & door frame widths, if the unit is not being assembled close to its final location
- SECOND : Check that you have enough floor area to complete the assembly
- THIRD: Retain your packaging until you have checked that ALL the parts are in the packs.
- FOURTH :Sort out the parts and fittings as shown, assemble product step by step
- It is preferable to rest the product on a soft surface to avoid damage during assembly
- Do not over tighten screws and fittings.
- Re-Tighten all screws and fitting periodically.

Guide Me

Multi-Pack Table
 COMPONENT Pack NO

- BOX: 1 / 2 + 2 / 2**
- HOOK
 - DOOR = 3x
 - SHELF = 3x
 - SHIRT HANGER = 12x
 - RIGHT SIDE PANEL = 1x
 - DOOR SUPPORT = 12x
 - COAT HANGER = 1x
 - FIXED SHELF = 1x
 - TOP = 1x
 - LIZINE LEFT = 1x
 - BACK PANEL = 3x
 - LIZINE RIGHT = 1x
 - BASE = 1x
 - LIZINE CENTER = 1x

Replacement packs cannot be provided without Component pack number and the part number / description

Show Me

No of People to Assemble

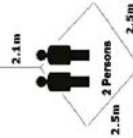

Approx Assembly Time

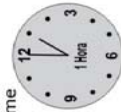

Preparation
Floor Space 2.5 x 2.5m
Height 2.1m

TOOLS REQUIRED

Tape Measure



Pozi No 2



Recycling- the packaging materials for this product may be recycled through your local recycling centre. When you want to dispose of the product it self, please consider donating it to a local charitable organization, otherwise recycle it through your local recycling centre.

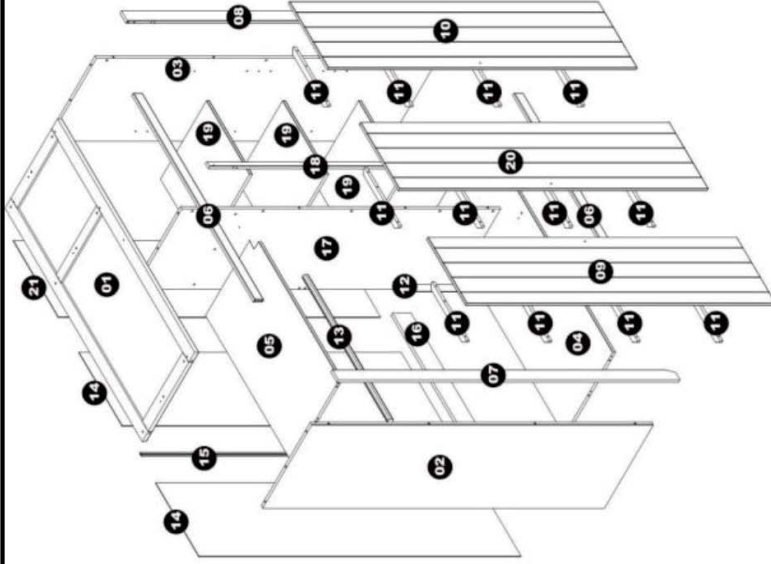

A		48	J		04
B		70	K		06
C		16	L		02
D		60	M		15
E		01	N		01
F		03	P		04
G		13	R		03
H		73	S		12
			T		01
			Q		02

01

Assemble on a clean soft surface to avoid damage.

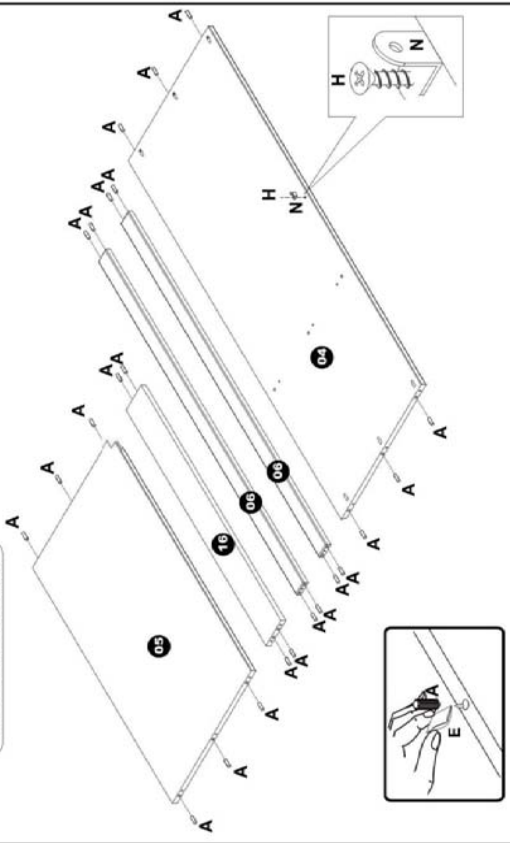

02

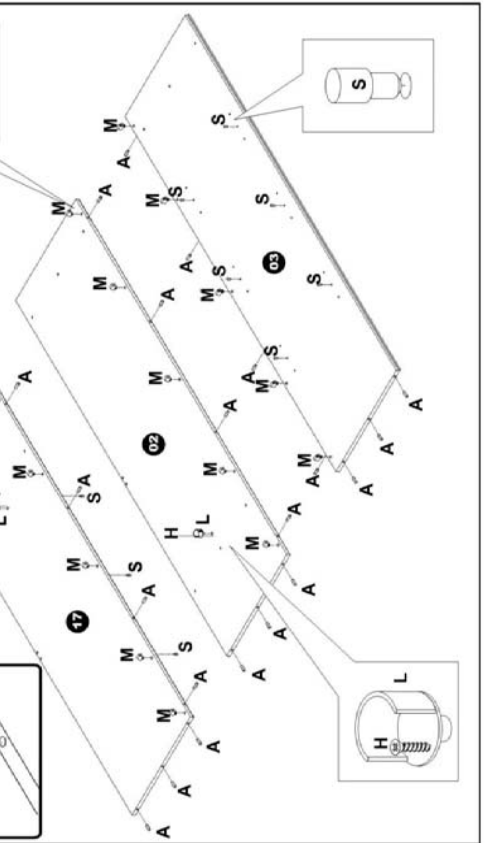

03

Assemble on a clean soft surface to avoid damage.

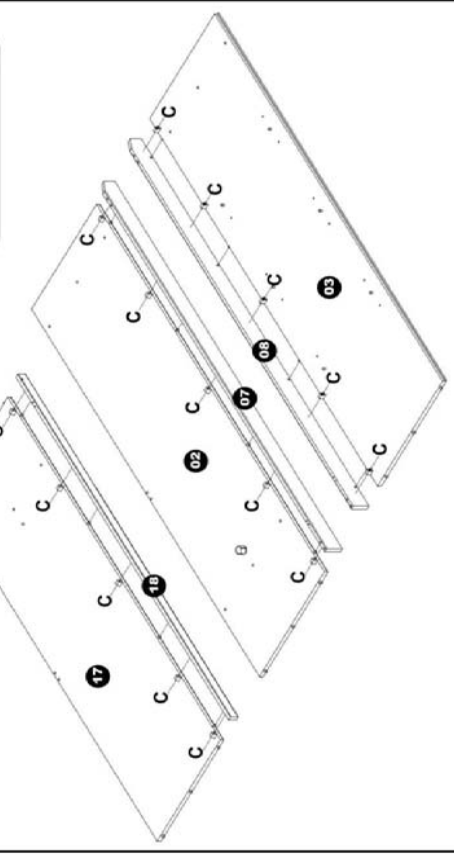

04

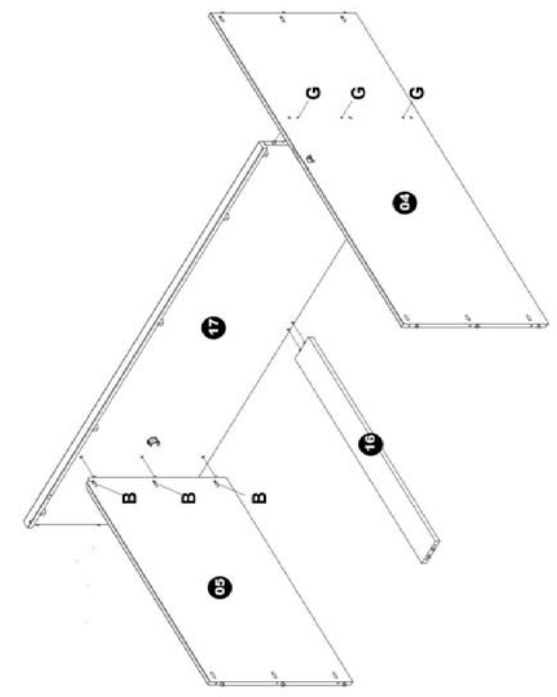

07

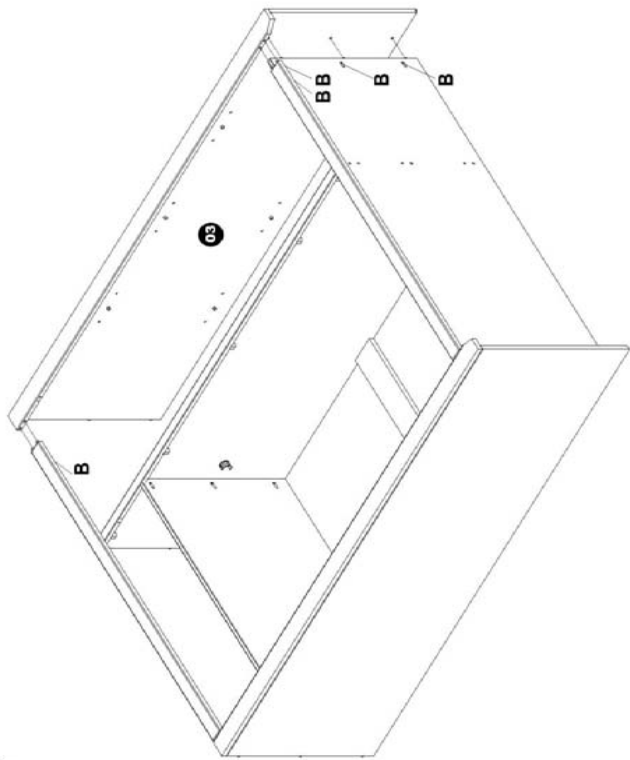

08

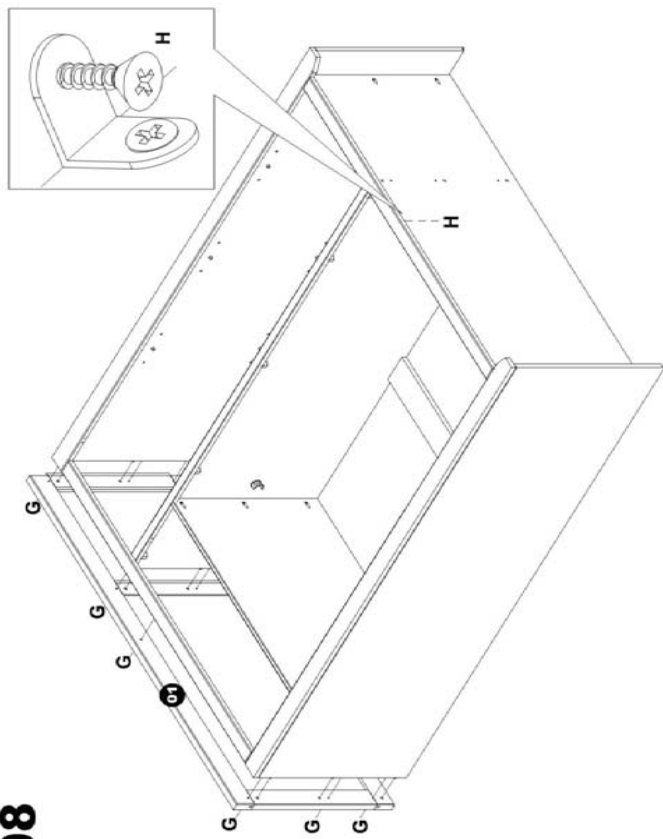

05

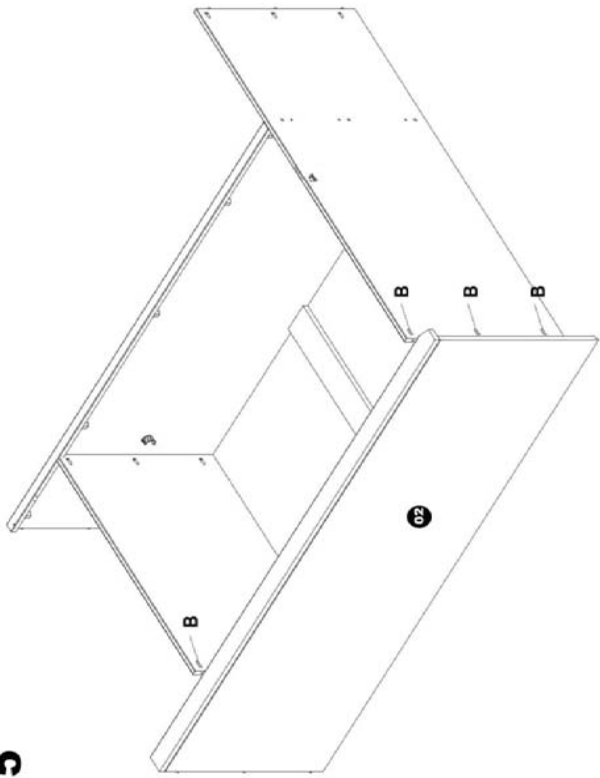

06

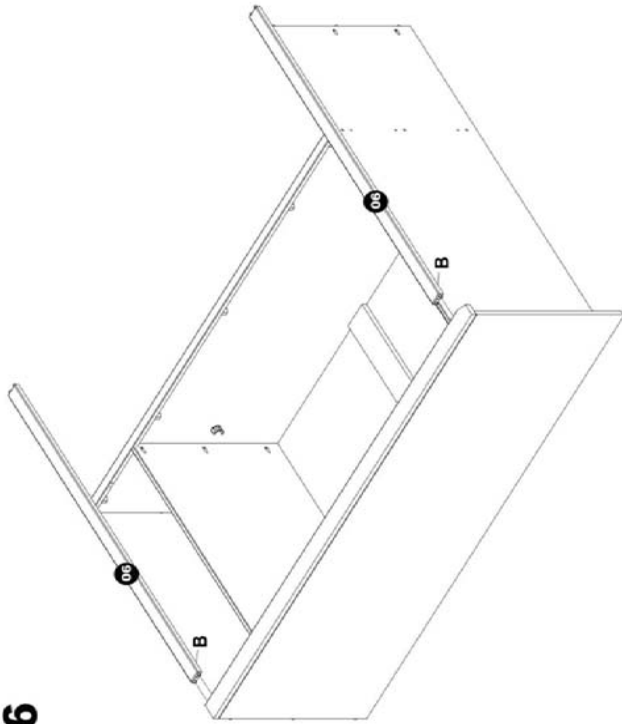

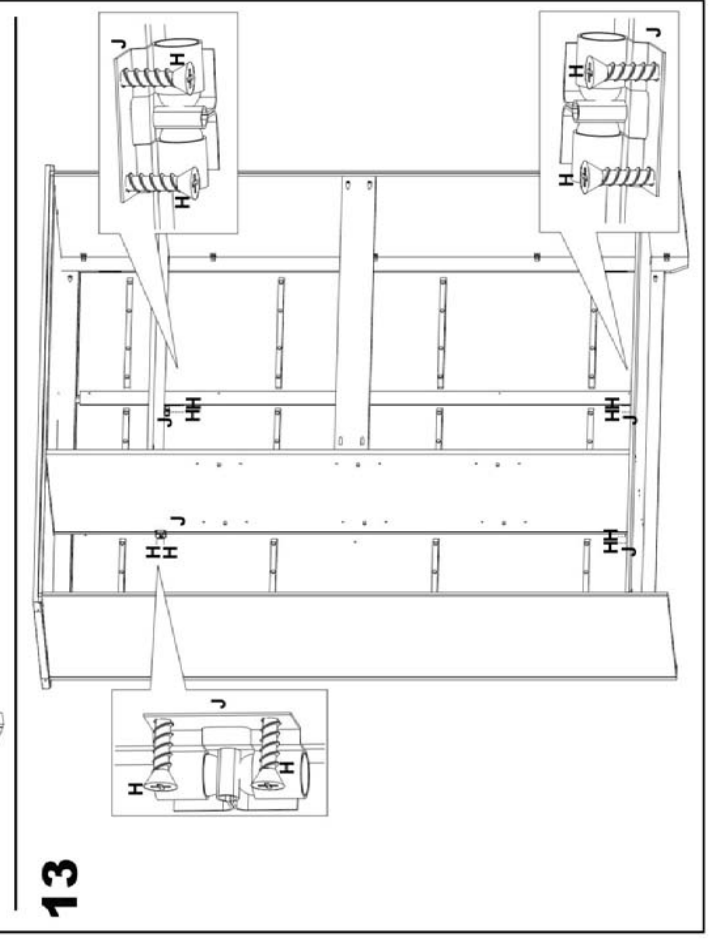
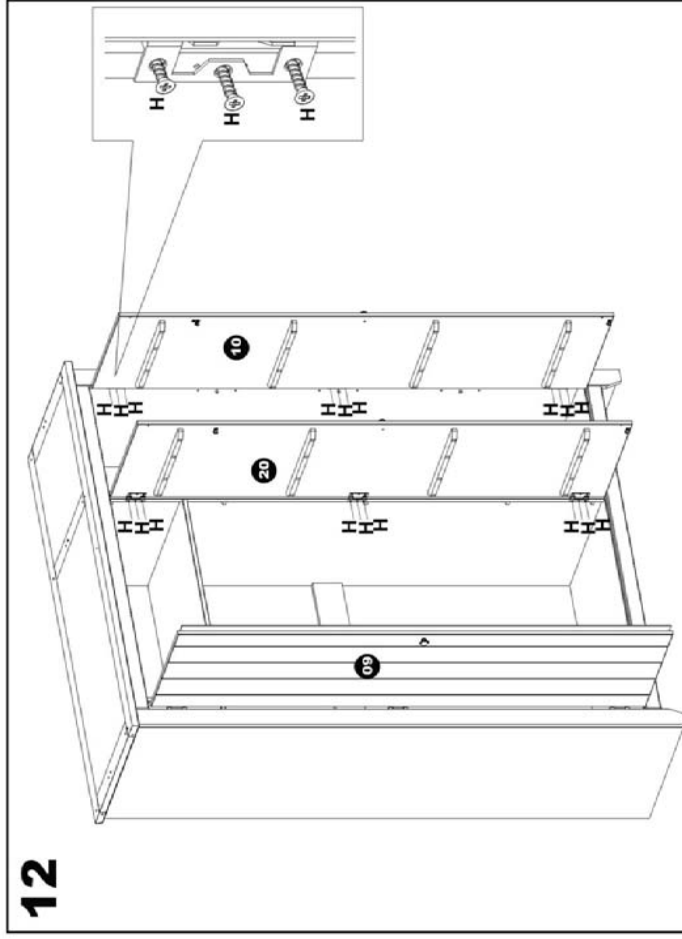
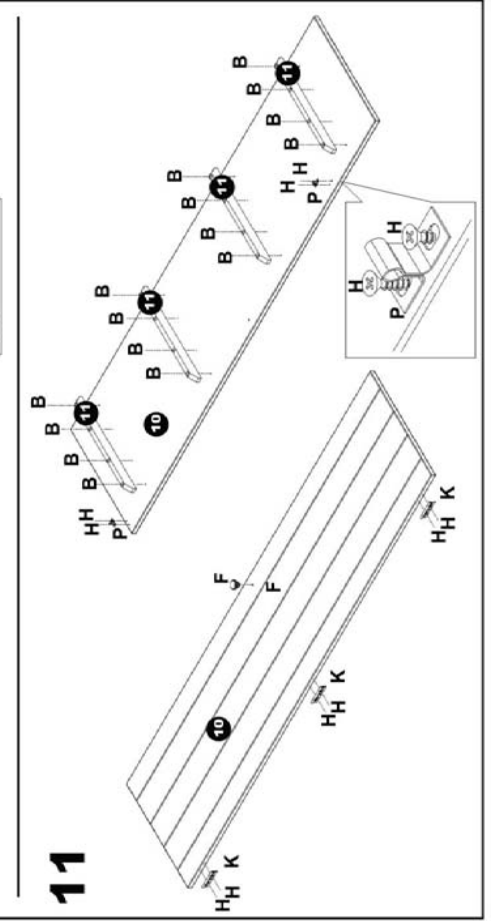
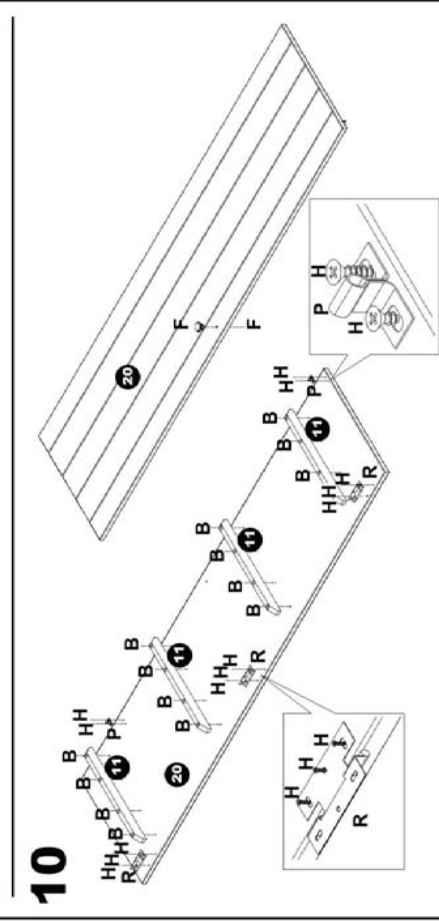
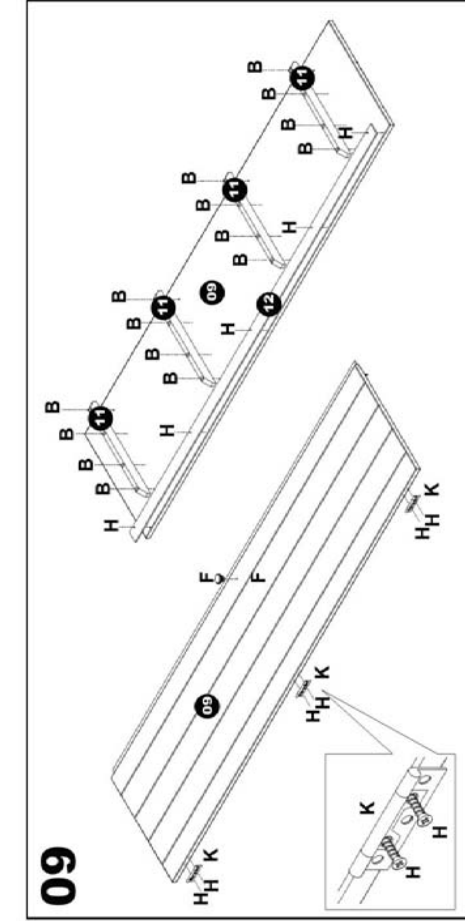

16

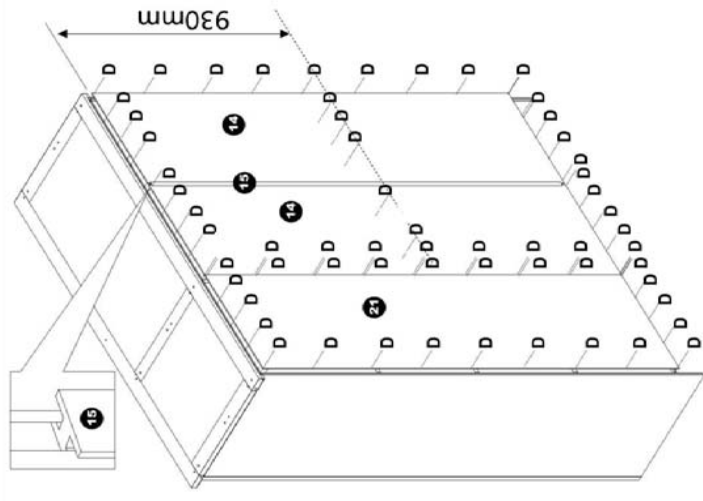

17

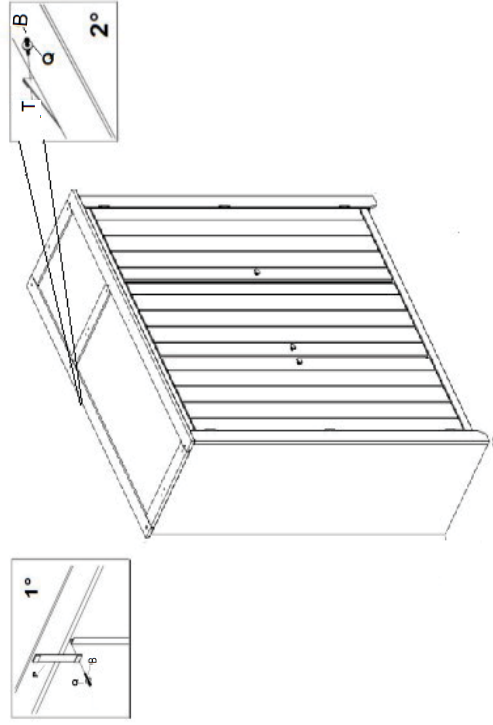

14

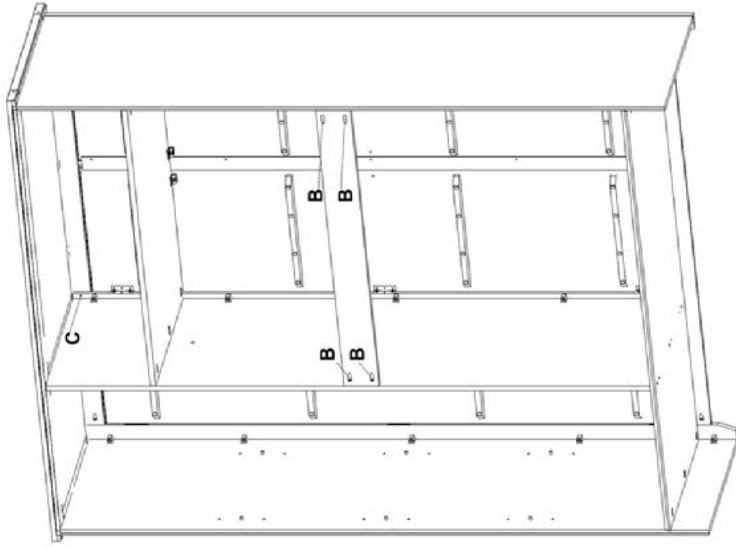

15

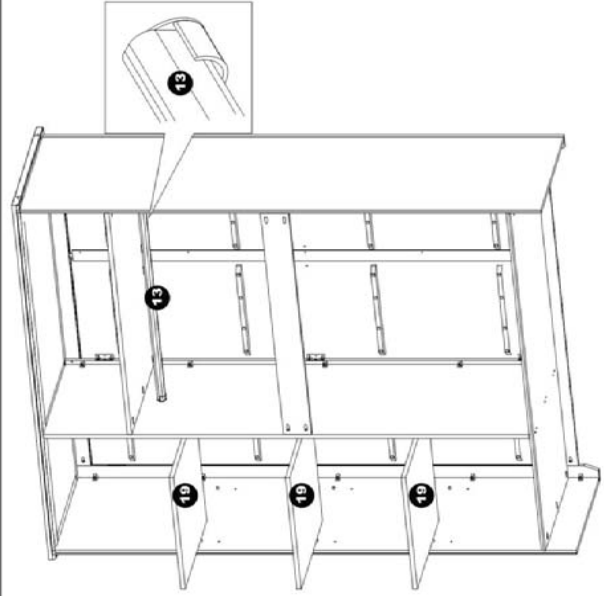

WALL ATTACHMENT GUIDE

WARNINGS!

- This unit is provided with a safety wall strap to prevent accidental tipping. It is important that the strap is correctly fitted. Failure to fit the strap could lead to serious injury.
- Never allow children to climb or hang on drawers, doors or shelves.
- Place heaviest items in the lower drawers or shelves.
- Never open more than one drawer at a time.
- From time to time check the fitting to ensure the wall plugs or screws do not become loose.
- Always ensure the wall to be drilled is free from hidden electrical wires, water and gas pipes.

YOU WILL NEED:

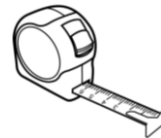
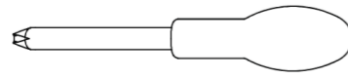

HARDWARE:

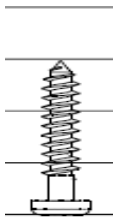

Screw
(to attach strap to product)

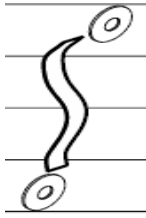

Strap and washers

Wall fixings (plugs and screws) are not included please source suitable fixings for your wall type. If in doubt, please consult a qualified tradesperson.



Wood
If fixing to wood make sure that it isn't chipboard as screws can easily pull away from the core structure

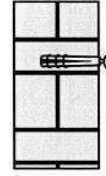

Brick or Masonry
Use an appropriate wall plug provided you are sure your wall is sound

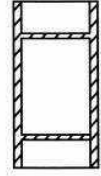

Cavity Wall
Special toggle wall plugs are needed, seek expert advice

Step 1.

Attach strap using screw and washer provided to the product.

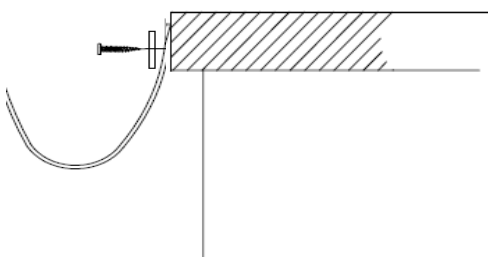

Step 2.

Mark the desired position of the hole on to the wall with a pencil.
Drill and insert suitable screw (not included) for wall through the washer and strap into a wall plug (not included) in the wall.

