



Birlea

Suppliers of inspiration

Assembly Instructions

Thank you for
purchasing a
Birlea product.

For a chance to win a Love 2 Shop voucher simply post a picture of your new product on your preferred social channels tagging Birlea Furniture and using the hashtag **#ShareYourStyle** and **#Birlea**. One winner will be selected at random each month.

To view our full terms and conditions please visit www.birlea.com

Are you happy with your purchase?

Yes: That's great, we would love to hear more from you. Please leave us a review on our social media channels or Trustpilot. Your feedback will be greatly appreciated.

No: If for any reason there is something missing, indifferent or incorrect with your order, please contact the retailer you purchased the item from. We will work with the retailer to resolve your issue as quickly as possible.



ASSEMBLY INSTRUCTIONS **150CM CROXLEY RATTAN BED**

IMPORTANT : READ THESE INSTRUCTIONS CAREFULLY BEFORE ATTEMPTING TO ASSEMBLE OR USE YOUR 150CM CROXLEY RATTAN BED.

PLEASE KEEP THESE INSTRUCTIONS FOR FUTURE REFERENCE.

ASSEMBLY:

Assembly should be carried out with this item laying flat, not standing upright.
Assemble on a soft, clean surface to prevent damages.

HEALTH & SAFETY:

DO NOT use this product if any parts are missing, damaged or worn.
DO NOT use this product unless all fixings are secured.
Always use on a level, even surface.

CARE & MAINTENANCE:

Periodically check all screws & fixings to ensure they are secure.
DO NOT push this product as this will cause damage.
Always lift this product with two people to repositions.
Keep any sharp objects away from this product.

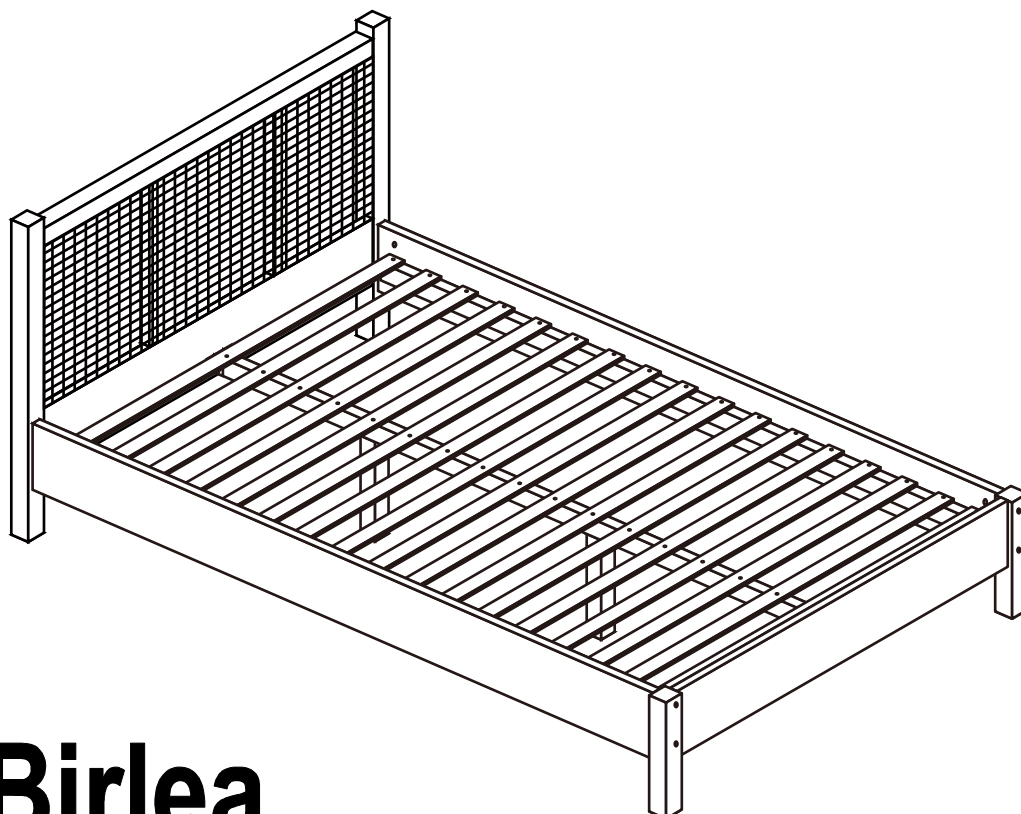



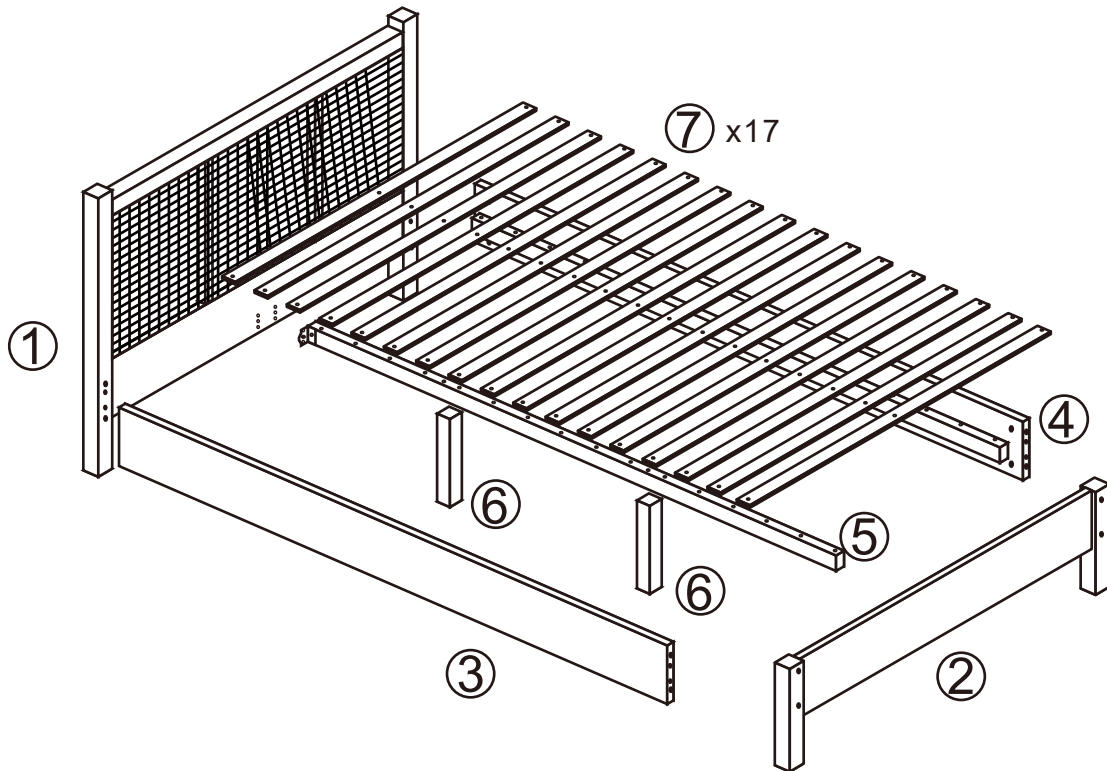

Birlea

Suppliers of inspiration

www.birlea.com



Parts List				Hardware List		
Part	Description	Box	Qty	Part	Description	Qty
1	Headboard	2	1	A	80mm Bolt 	8
2	Footboard	2	1	B	Bracket 	2
3	Left siderail	1	1	C	14mm Screw 	16
4	Right siderail	1	1	D	70mm Screw 	2
5	Centre Rail	1	1	E	25mm Screw 	51
6	Support Leg	1	1	F	30mm Dowel 	8
7	Slats	2	1 sets	G	Allen Key 	1

****You will need a screwdriver for assembly.**



Birlea

Suppliers of inspiration

www.birlea.com

STEP 1 Assembly the headboard(1),footboard(2),left siderail(3) and right siderail(4) by hardware A,F.
DO NOT use any power tools as this may damage the frame and will invalidate any claim.

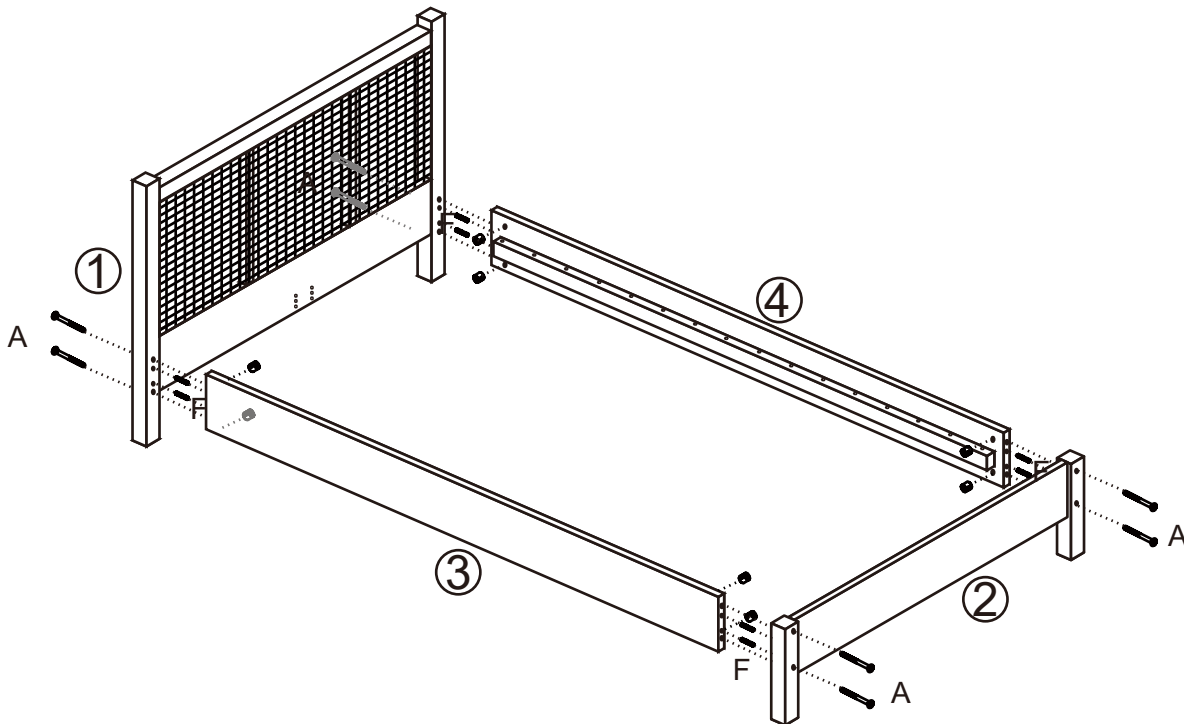

STEP 2 Attach hardware B by hardware C on headboard(1) and footboard(2).
DO NOT use any power tools as this may damage the frame and will invalidate any claim.

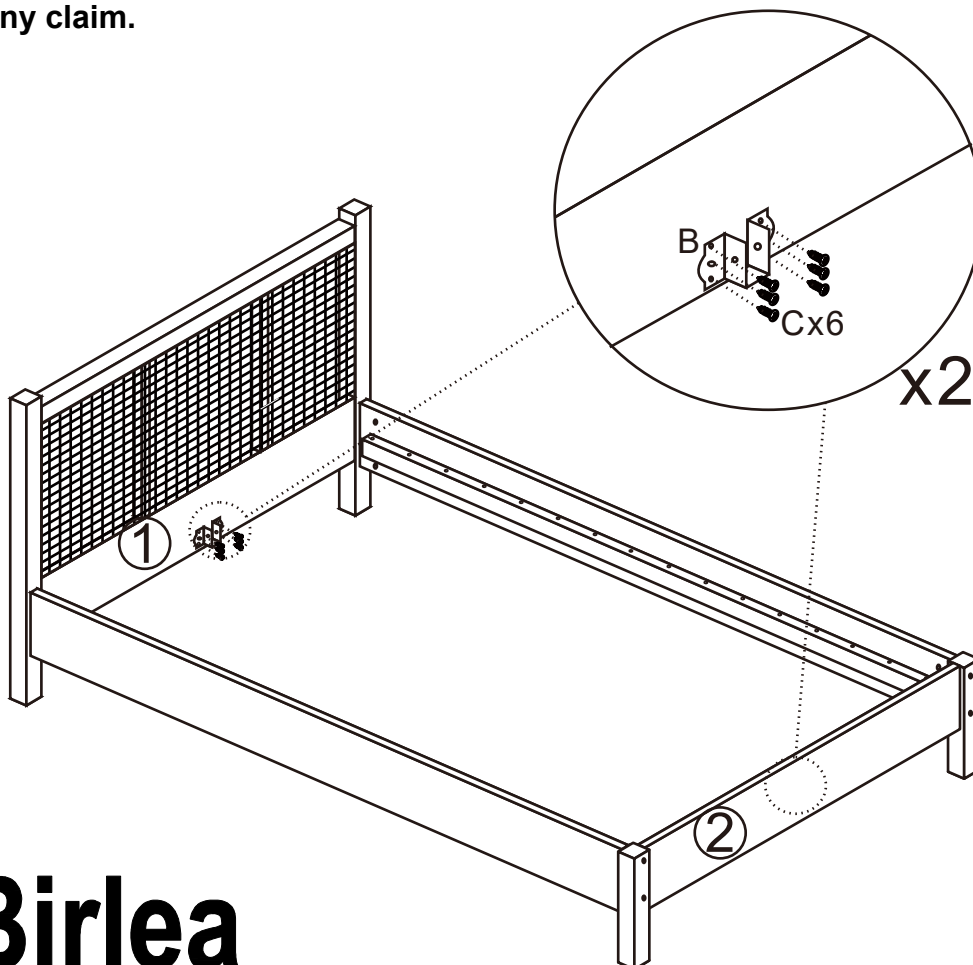

Birlea

Suppliers of inspiration

www.birlea.com

STEP 3 Assembly the centre rail(5) with support leg(6) by hardware D
DO NOT use any power tools as this may damage the frame and will invalidate any claim.

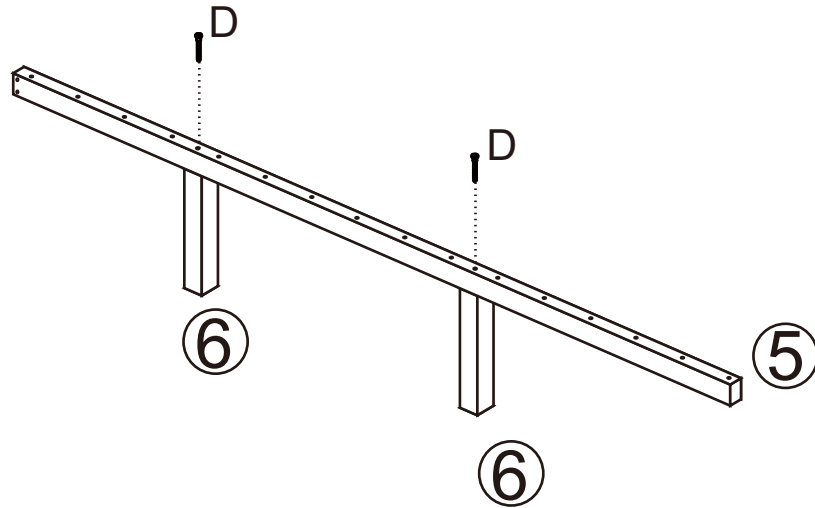

STEP 4 Attach centre rail(5) in to bracket B, and screw with hardware C.
DO NOT use any power tools as this may damage the frame and will invalidate any claim.

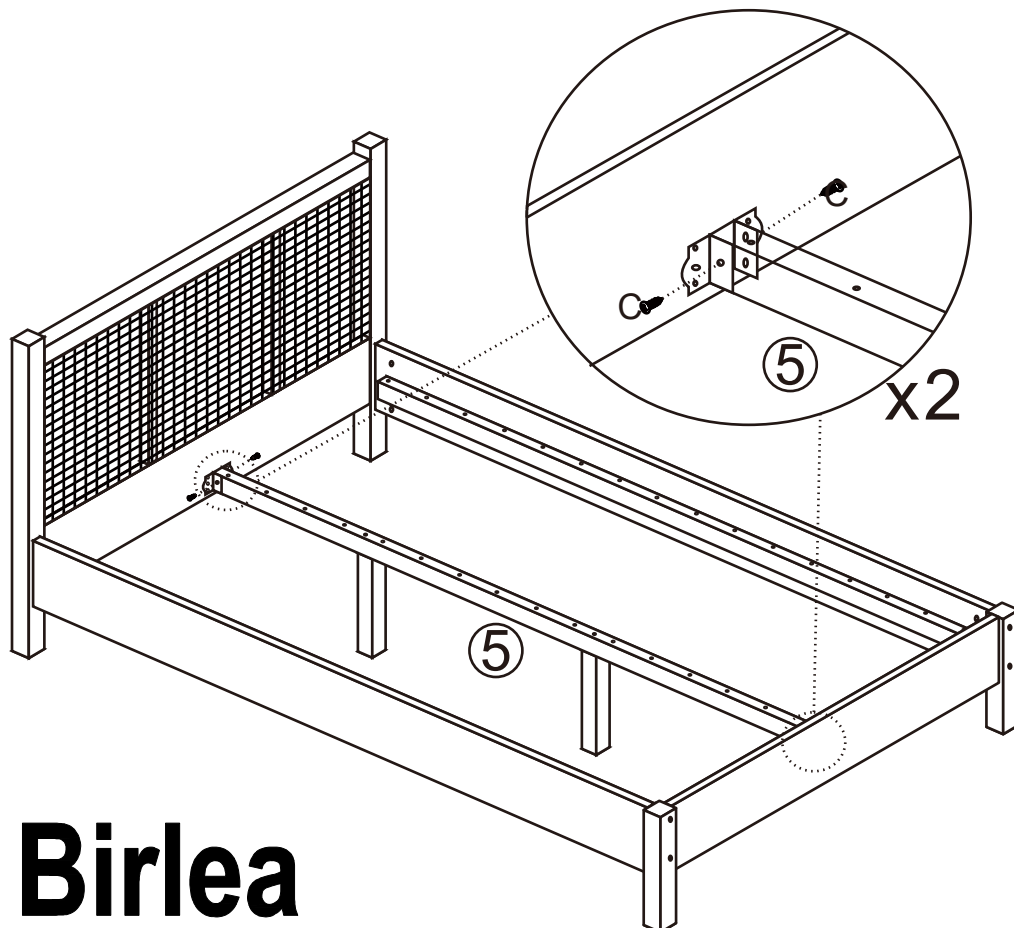

Birlea

Suppliers of inspiration

www.birlea.com

STEP 3 Attach the bed slats(7) with bed frame by hardware E(the connect hole were pre-drilled)
DO NOT use any power tools as this may damage the frame and will invalidate any claim.

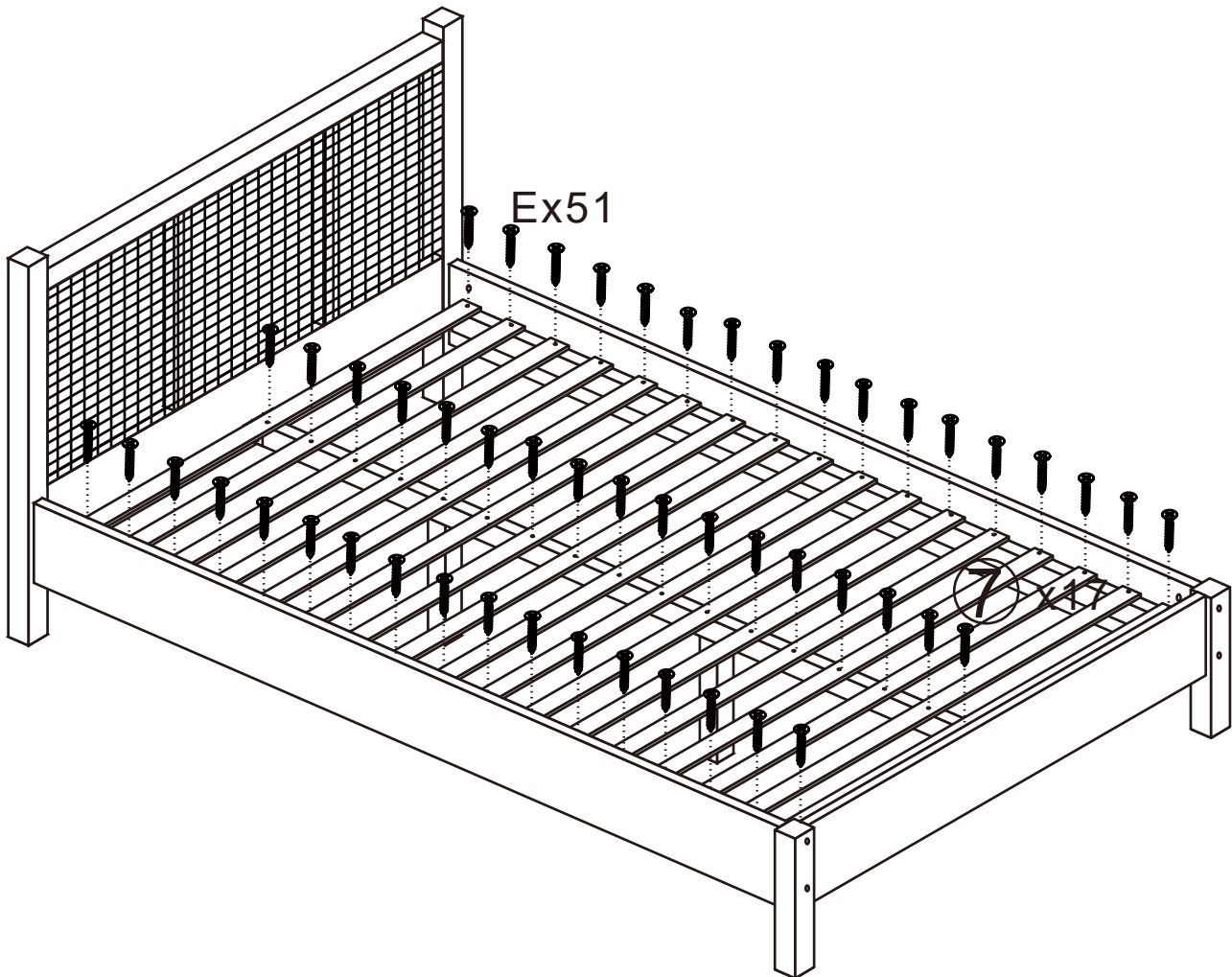

Additional Information:

- For complete product information, and dimension diagrams please visit the website www.birlea.com
- If you have any issues with your item please contact the retailer directly you purchased it from who will be able to resolve any issues with Birlea.
- Why don't you send us photos of your assembled furniture to info@birlea.com to be shared our #birleahome feature on instagram.



Birlea

Suppliers of inspiration

www.birlea.com