

# GREY TOLEDO 3 DOOR WARDROBE ASSEMBLY INSTRUCTIONS

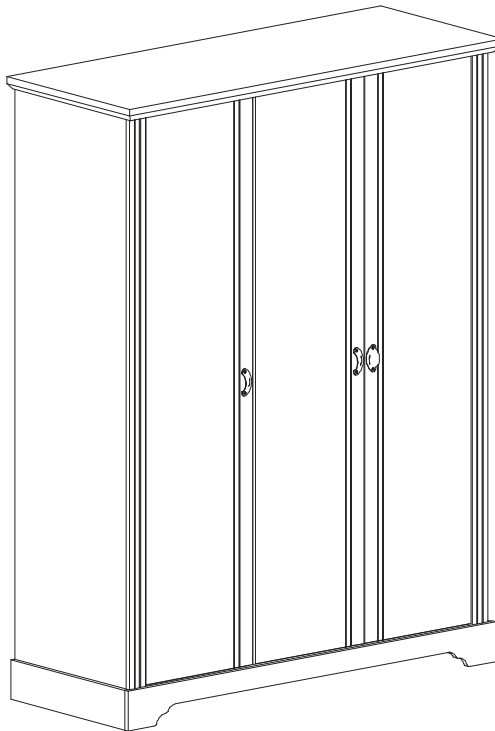

## IMPORTANT FOR DOMESTIC USE ONLY

PLEASE READ BEFORE YOU CONTINUE FURTHER

## CARE AND MAINTENANCE

- After unpacking this product please keep the original packaging in case it needs to be returned for any reason.
- Please ensure all fittings and parts are present before commencing with assembly.
  - Never drag or push products as this could cause damage to the joints making it inferior.
  - We strongly recommend that you keep children away from your work area.
  - We recommend that you lay a blanket or sheet on the floor to avoid damage to both your floor and the product.
  - Assemble this product as close to its final position as possible.
  - Do not place this product next to a radiator or in direct sunlight.
  - Do not drag or push items across your high gloss furniture as this may cause the surface to scratch
  - Wood is a natural product and may expand if subjected to damp and may shrink or crack if subjected to heat. Therefore it is recommended that room temperature is maintained, with no sudden temperature fluctuations.
  - Make sure any spillage is wiped off immediately.
  - Do not place hot or chilled items directly on to the surface, use a place mat or marking will occur.
  - For general cleaning use a soft cotton or micro fibre cloth, and do not use detergents of any kind.
  - From time to time it may be necessary to tighten fittings, regular inspections should be carried out.
  - Do not place on a wet or damp floor as staining may occur to your floor.

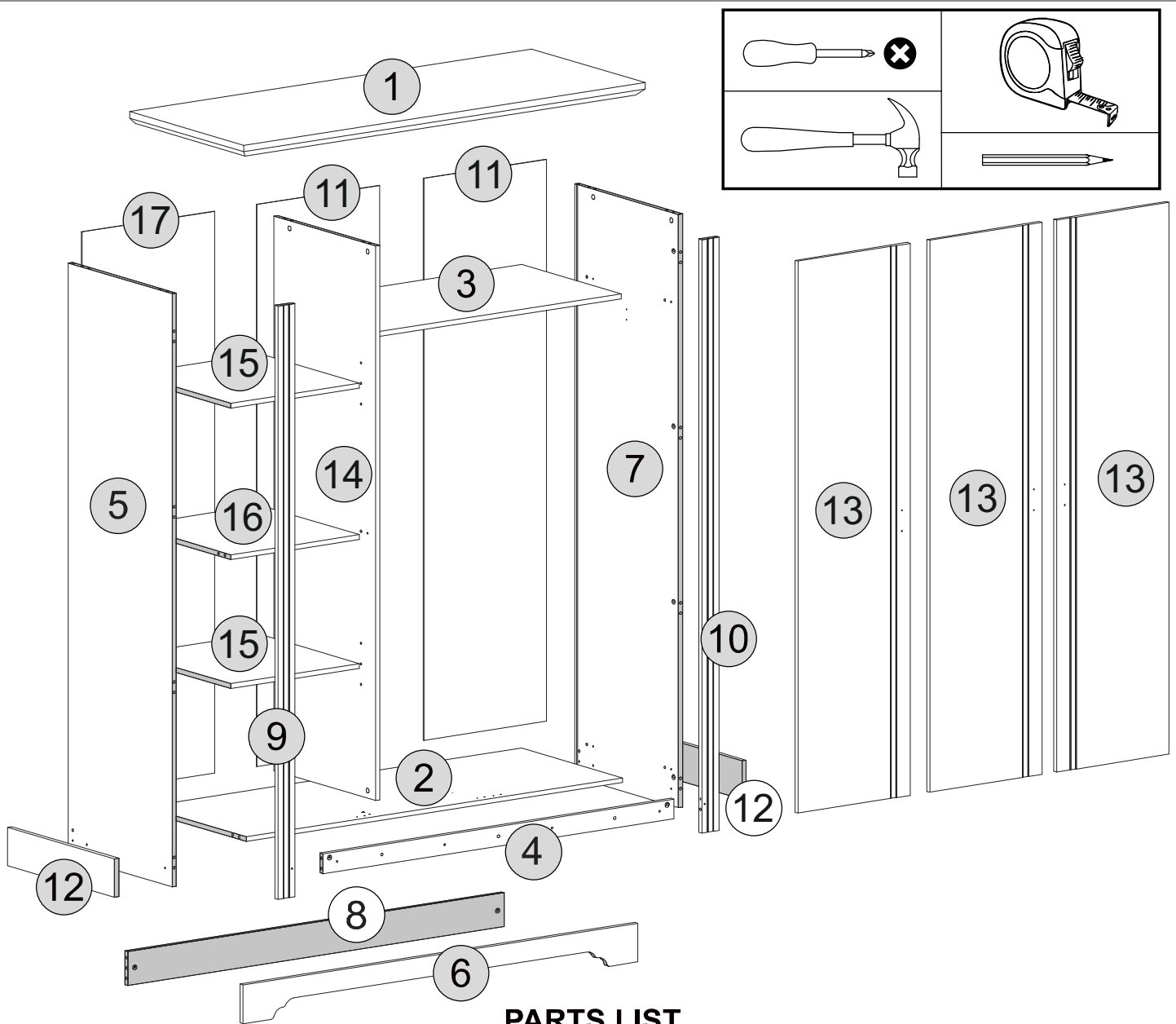

**PARTS LIST**

**Please Note:**  
The below parts have all been stamped with the part number to help identify them during assembly.

Part Number	Part Code	Part Description	Quantity	Carton
1	S100-101-127-HV1-01	Top Panel	1	1/4
2	S100-101-127-HV1-02	Base	1	1/4
3	S100-101-127-HV1-03	Shelf	1	1/4
4	S100-101-127-HV1-04	Crossbeam	1	1/4
5	S100-101-127-HV1-05	Left Side Panel	1	2/4
6	S100-101-127-HV1-06	Front Plinth	1	1/4
7	S100-101-127-HV1-07	Right Side Panel	1	2/4
8	S100-101-127-HV1-08	Back Baseboard	1	1/4
9	S100-101-127-HV1-09	Left Front Upright	1	2/4
10	S100-101-127-HV1-10	Right Front Upright	1	3/4
11	S100-101-127-HV1-11	Back Panel	2	2/4
12	S100-101-127-HV1-12	Side Plinth	2	2/4
13	S100-101-127-HV1-13	Door	3	4/4
14	S100-101-127-HV1-14	Division Panel	1	3/4
15	S100-101-127-HV1-15	Adjustable Shelf	2	3/4
16	S100-101-127-HV1-16	Fixed Shelf	1	3/4
17	S100-101-127-HV1-17	Large Back Panel	1	2/4

# FITTINGS LIST

<b>A</b> x 32  +2 <b>Cam Bolt 32xØ6mm</b>	<b>B</b> x 32  +2 <b>Can Nut Ø15 mm</b>	<b>C</b> x 37  +2 <b>Dowel Ø8 x 30 mm</b>	<b>D</b> x 4  +1 <b>Washer Ø16x7 mm</b>	<b>E</b> x 6  <b>Roller Clasp</b>
<b>F</b> x 24  +2 <b>Screw Ø3.5 x 12 mm</b>	<b>G</b> x 10  +2 <b>Screw Ø4 x 25 mm</b>	<b>H</b> x 35  +2 <b>Nail 10x10 Ringed 1,5x23 mm</b>	<b>I</b> x 5  +1 <b>Plastic Foot L 19x17x8mm Ø2mm</b>	<b>J</b> x 2  <b>Glue 10G</b>
<b>K</b> x 18  +2 <b>Hole Plugs 19mm</b>	<b>L</b> x 48  +2 <b>Screw Ø4 x 14 mm</b>	<b>M</b> x 4  +1 <b>Support Metallic L 18x18 mm</b>	<b>N</b> x 24  +2 <b>TRIANGLE SUPPORT ANGLE</b>	<b>O</b> x 2  +1 <b>Screw Ø3 5 x 30 mm</b>
<b>P</b> x 24  +2 <b>Screw Ø3 x 16 mm</b>	<b>Q</b> x 2  <b>Strap 200x20x1mm</b>	<b>R</b> x 2  <b>Support Pipe Oblongo Metallic</b>	<b>S</b> x 8  +1 <b>Shelf Support 7x6</b>	<b>T</b> x 3  <b>Handle With Screws</b>
<b>U</b> x 12  +2 <b>Back Panel Bracket 14x14 mm</b>	<b>V</b> x 6  <b>HINGE SHIM 26mm H7</b>	<b>W</b> x 6  <b>HINGE 26mm 90°</b>	<b>X</b> x 3  <b>Hinge Shim 26MM D5</b>	<b>Y</b> x 3  <b>Hinge 26MM High Lap</b>
<b>Z</b> x 1  <b>Pipe Oblongo 864x30X16X0,60MM</b>	<b>A1</b> x 1  <b>PROFILE "H" 1719 mm</b>			

## TIPS FOR FITTINGS CAM-LOCKS

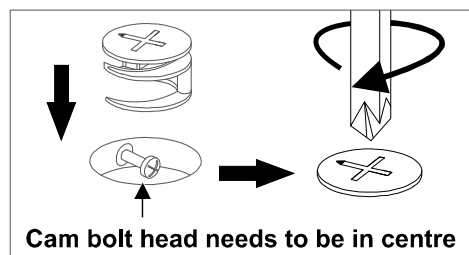
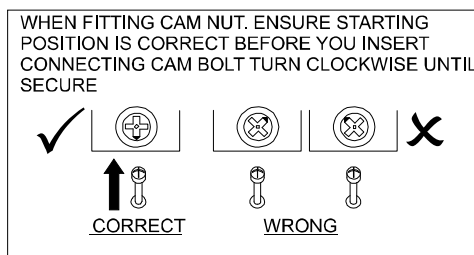

### CAMBOLT

Tighten until shoulder in flush with panel. Do not overtighten or undertighten (see example beside)

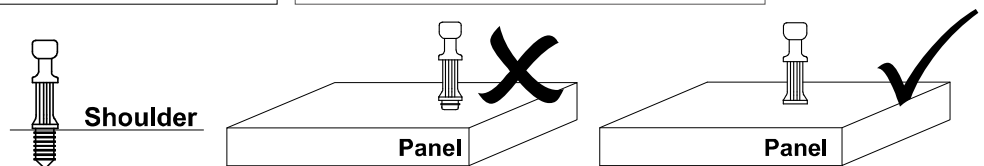

# STEP 1

## PARTS REQUIRED

7 - RIGHT SIDE PANEL x1

## HARDWARE REQUIRED

C  06

H  02

I  02

J  01

## TOOLS REQUIRED

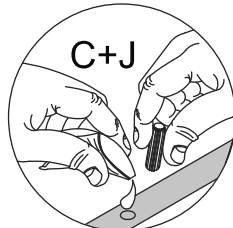
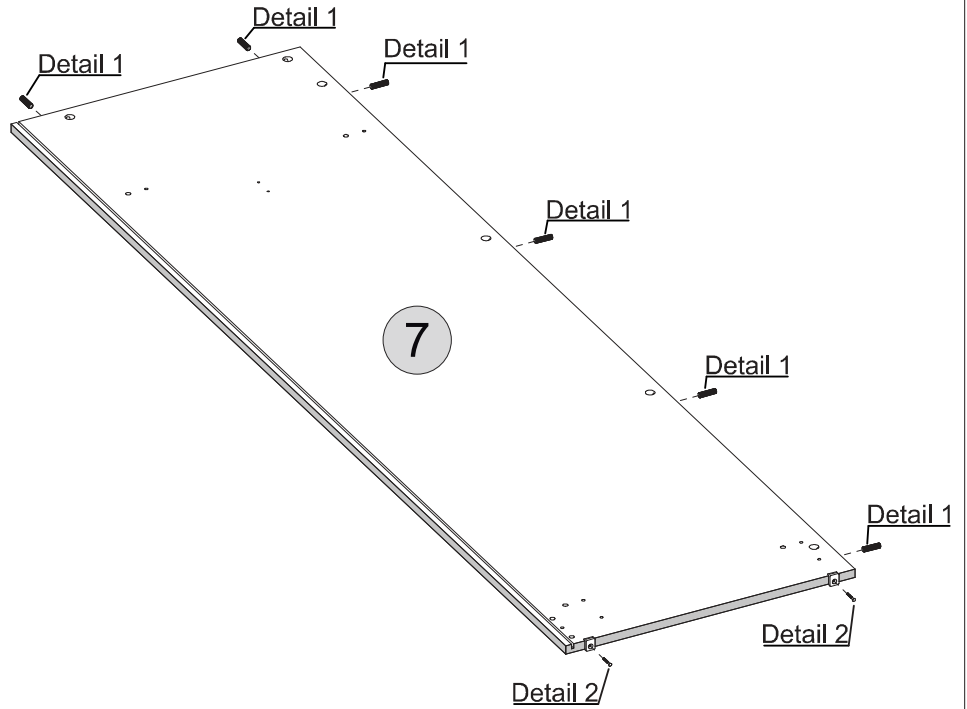
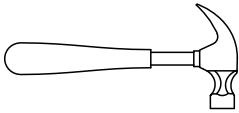

Detail 1

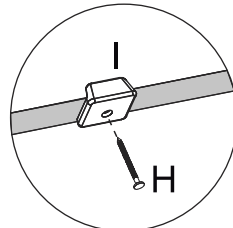

Detail 2

# STEP 2

## PARTS REQUIRED

7 - RIGHT SIDE PANEL x1

## HARDWARE REQUIRED

A  05

L  02

R  01

## TOOLS REQUIRED

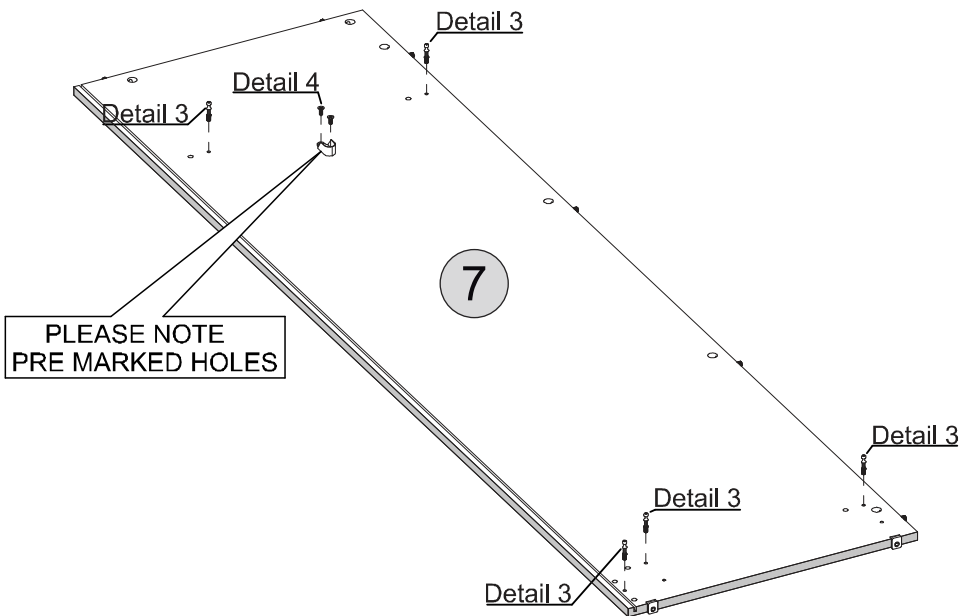
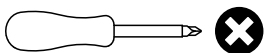

PLEASE NOTE  
PRE MARKED HOLES

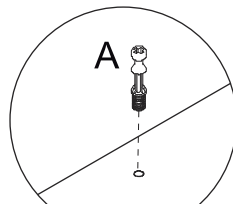

Detail 3

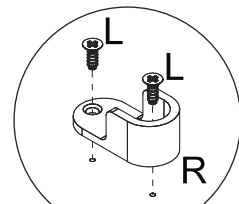
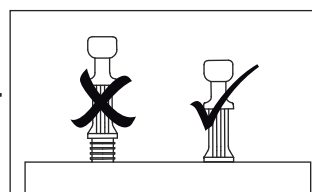

Detail 4



# STEP 3

## PARTS REQUIRED

5- LEFT SIDE PANEL x1

## HARDWARE REQUIRED

C  06

H  02

I  02

J  01

## TOOLS REQUIRED

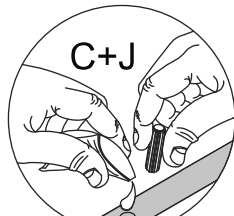
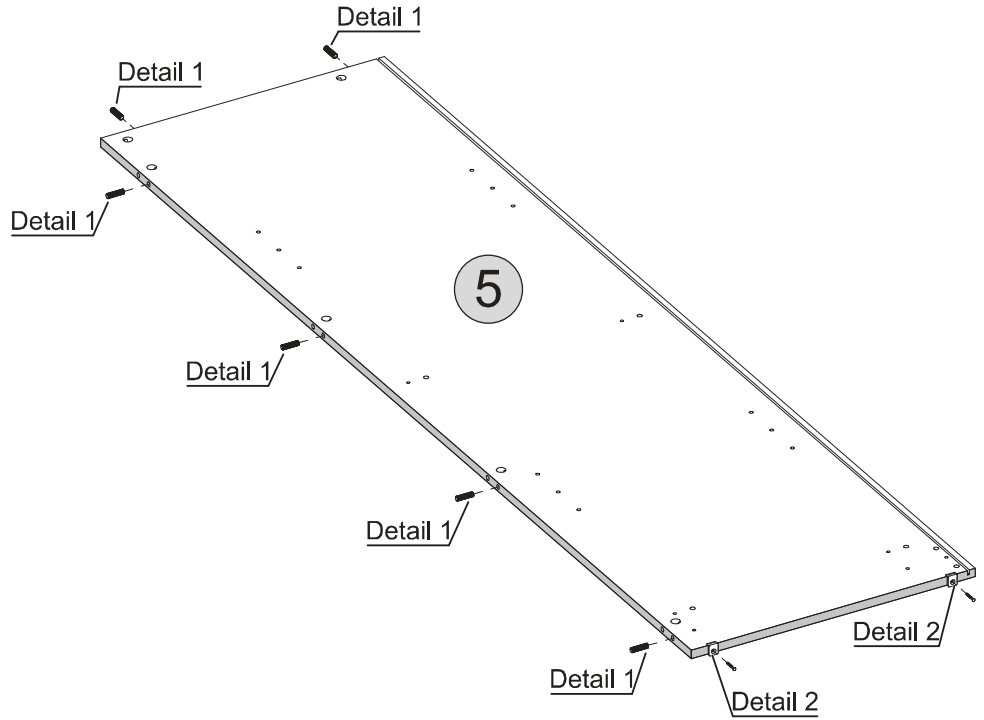
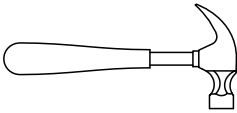

Detail 1

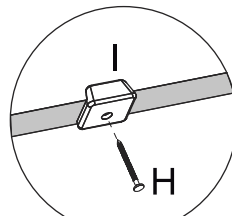

Detail 2

# STEP 4

## PARTS REQUIRED

5- LEFT SIDE PANEL x1

## HARDWARE REQUIRED

A  05

S  04

## TOOLS REQUIRED

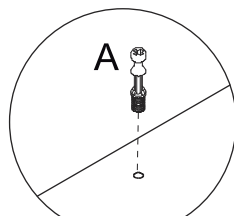
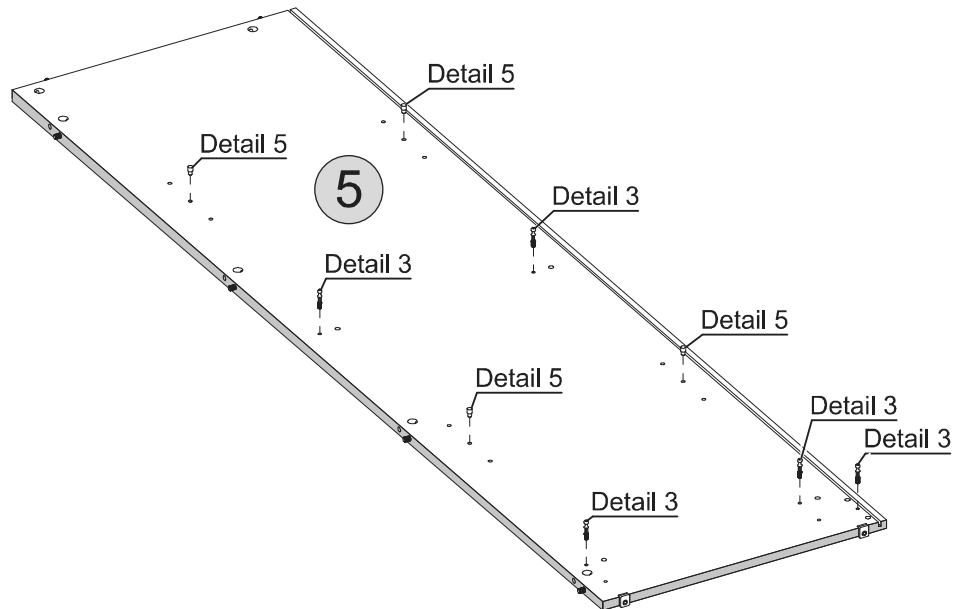
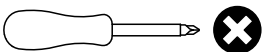
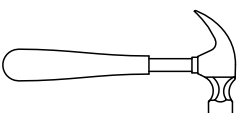

Detail 3

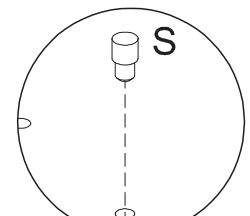
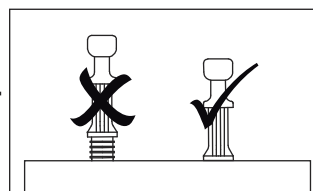

Detail 5

# STEP 5

## PARTS REQUIRED

14 - DIVISION PANEL x1

## HARDWARE REQUIRED

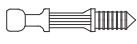
A  02

C  04

J  01

S  04

## TOOLS REQUIRED

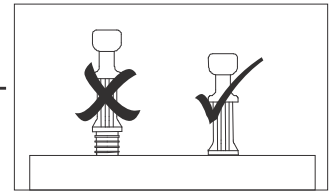
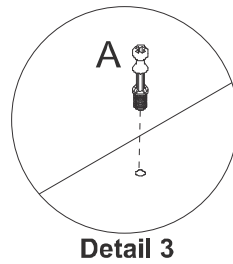
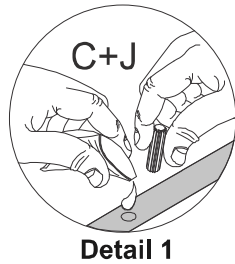
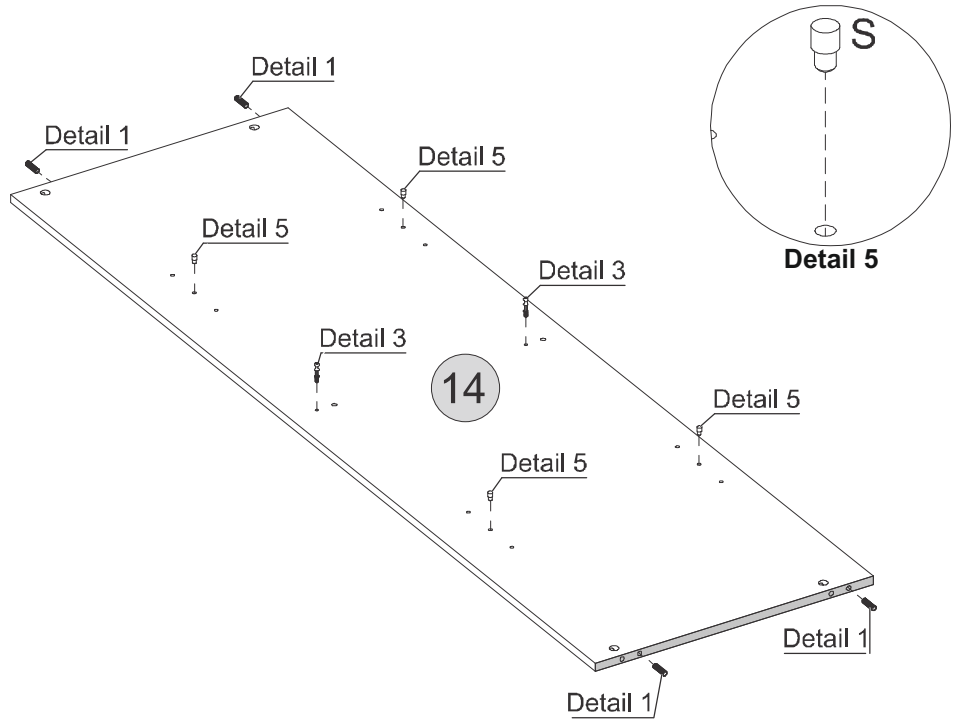
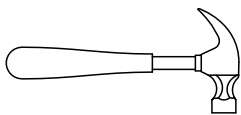
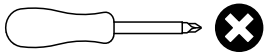



# STEP 6

## PARTS REQUIRED

14 - DIVISION PANEL x1

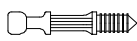
## HARDWARE REQUIRED

A  02

L  02

R  01

## TOOLS REQUIRED

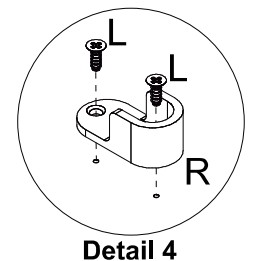
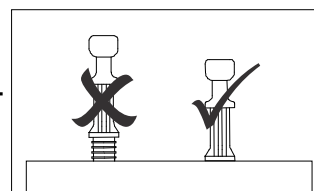
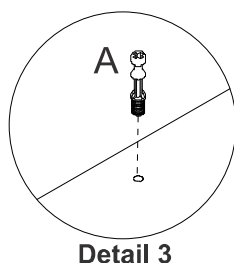
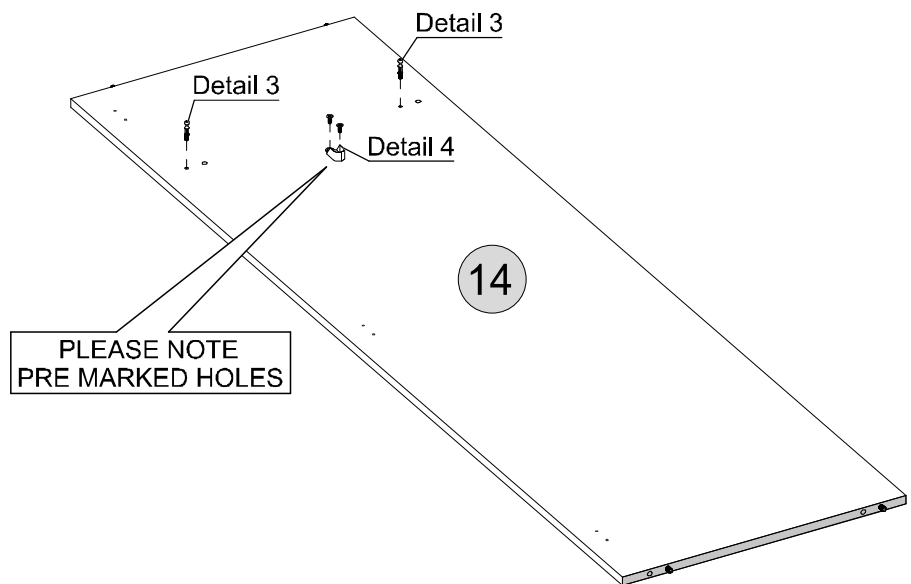
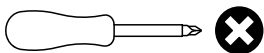

# STEP 7

## PARTS REQUIRED

14 - DIVISION PANEL x1

16 - FIXED SHELF x1

## HARDWARE REQUIRED

C  04

J  01

L  06

X  03

## TOOLS REQUIRED

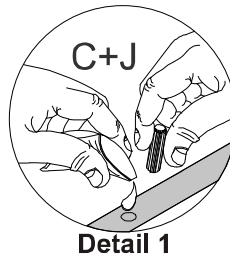
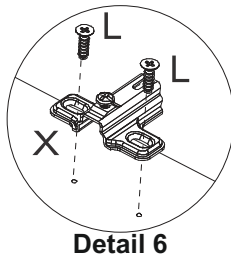
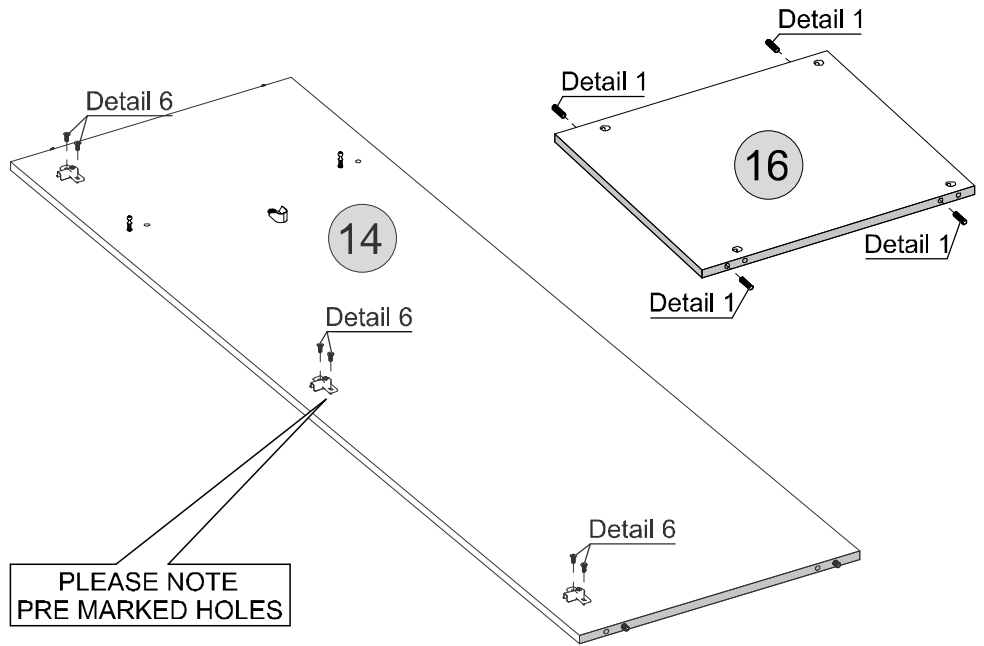
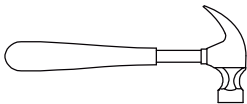
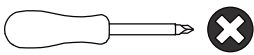

# STEP 8

## PARTS REQUIRED

2 - BASE x1

## HARDWARE REQUIRED

A  02

C  04

E  03

F  06

J  01

## TOOLS REQUIRED

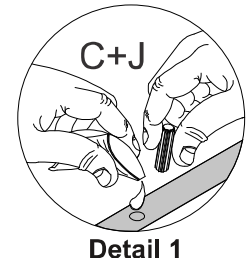
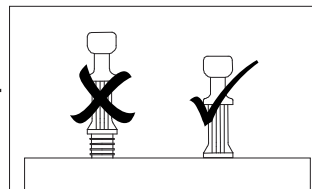
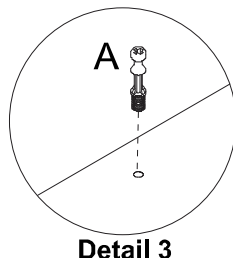
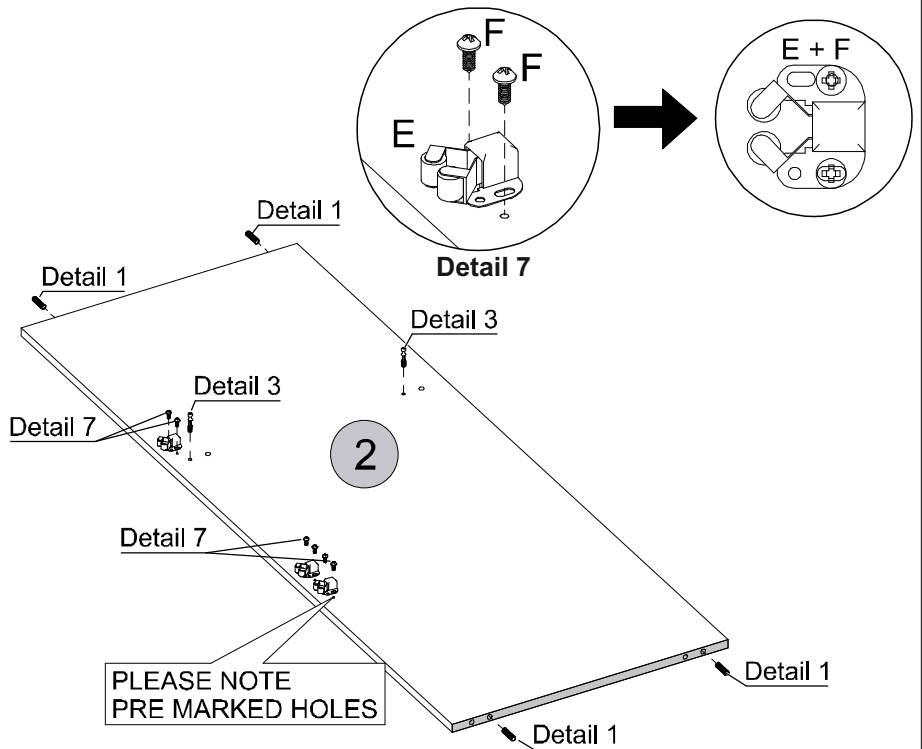
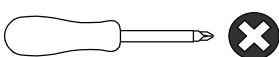
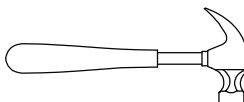

# STEP 9

## PARTS REQUIRED

2 - BASE x1

3 - SHELF x1

## HARDWARE REQUIRED

C  04

J  01

L  04

M  04

## TOOLS REQUIRED

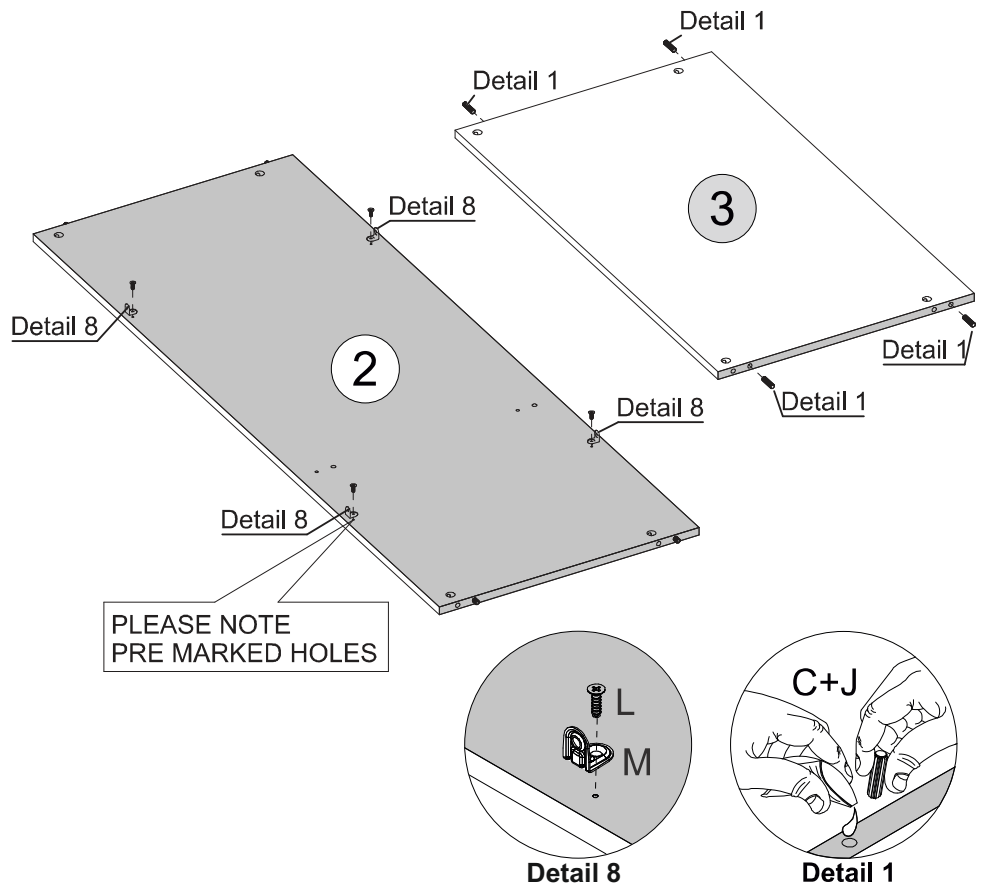
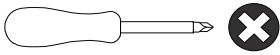

# STEP 10

## PARTS REQUIRED

4 - CROSSBEAM x1

6 - FRONT PLINTH x1

8 - BACK BASEBOARD x1

## HARDWARE REQUIRED

C  09

J  01

H  01

I  01

## TOOLS REQUIRED

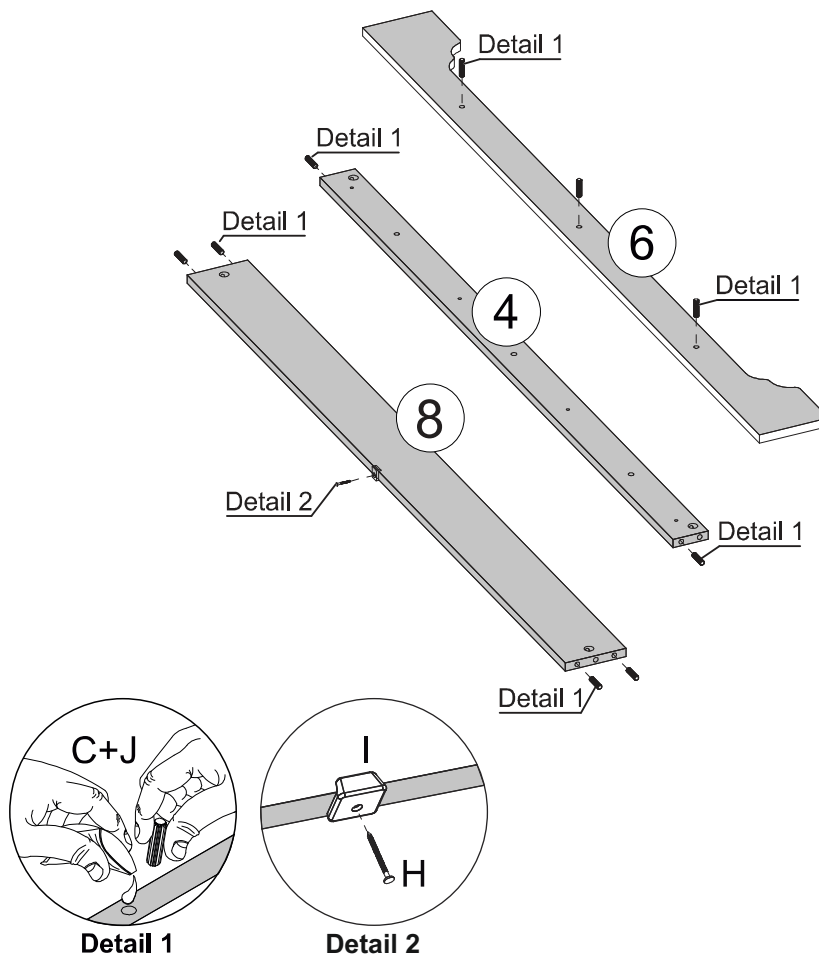
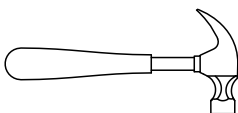

# STEP 11

## PARTS REQUIRED

3 - SHELF x1

14 - DIVISION PANEL x1

16 - FIXED SHELF x1

## HARDWARE REQUIRED

B  04

## TOOLS REQUIRED

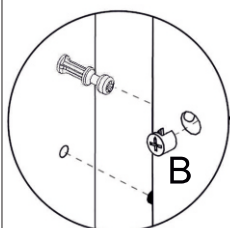
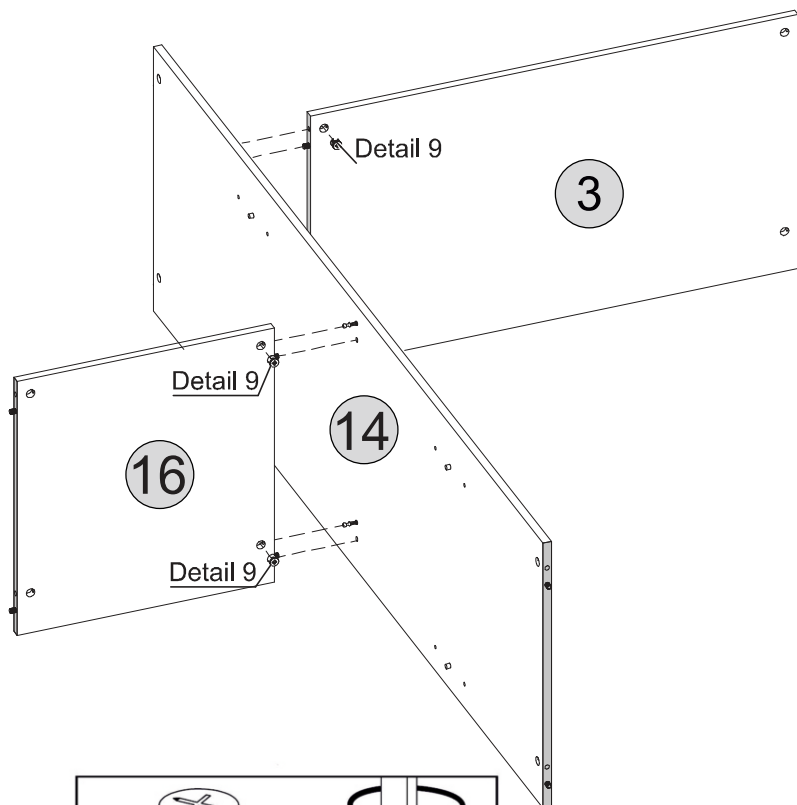
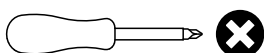

Detail 9

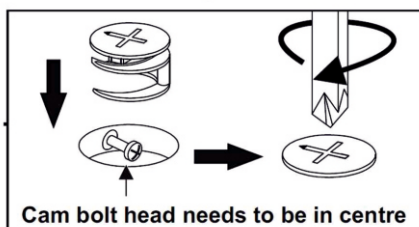

# STEP 12

## PARTS REQUIRED

2 - BASE x1

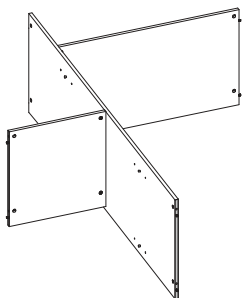

## HARDWARE REQUIRED

B  02

## TOOLS REQUIRED

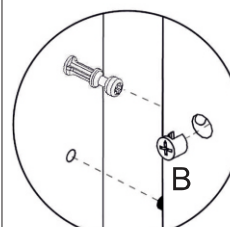
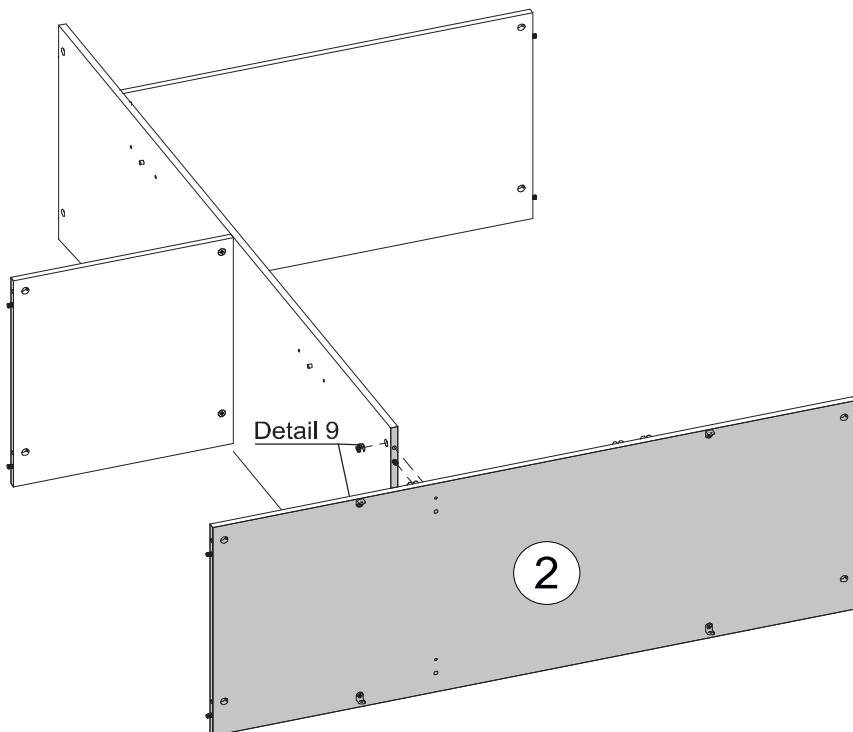
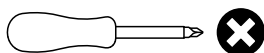

Detail 9

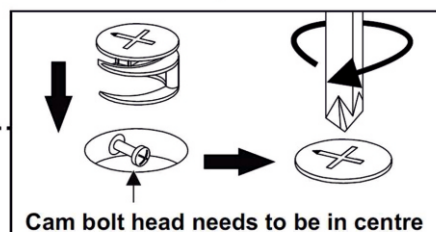

# STEP 13

**PARTS REQUIRED**

- 7 - RIGHT SIDE PANEL x1
- 8 - BACK BASEBOARD x1

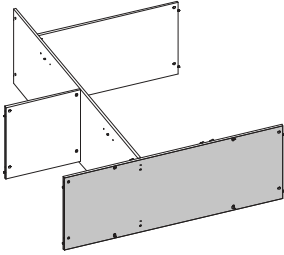

**HARDWARE REQUIRED**

- B  05

**TOOLS REQUIRED**

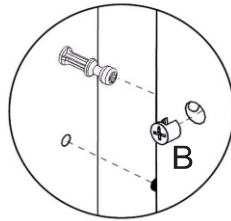
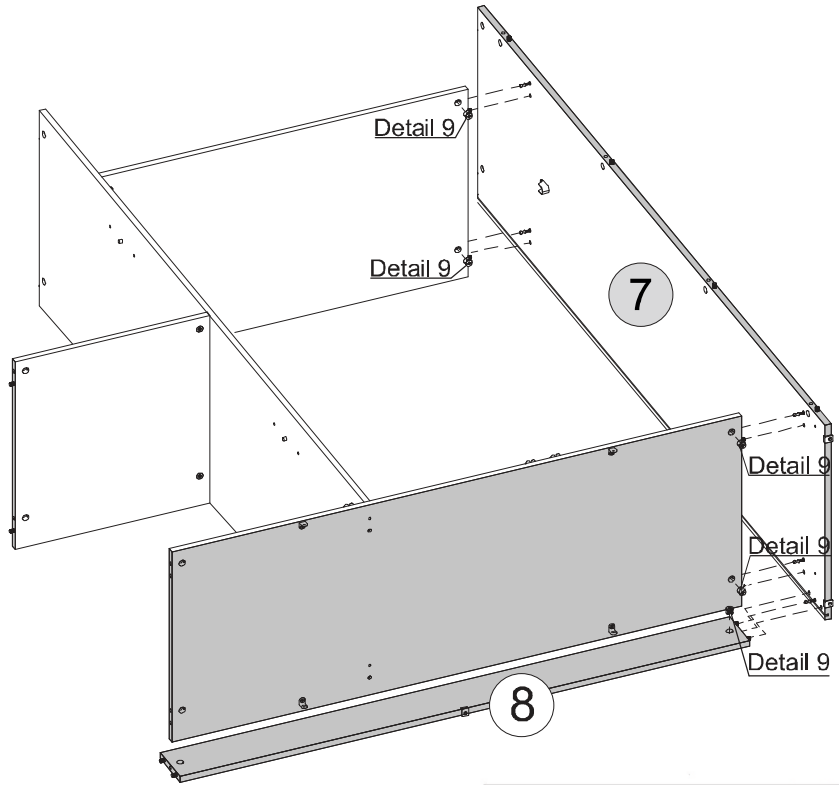
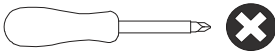

Detail 9

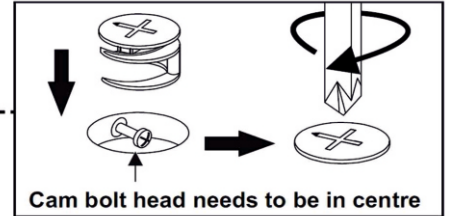

# STEP 14

**PARTS REQUIRED**

- 5 - LEFT SIDE PANEL x1

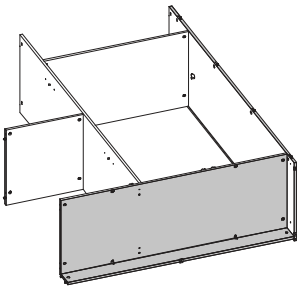

**HARDWARE REQUIRED**

- B  05

**TOOLS REQUIRED**

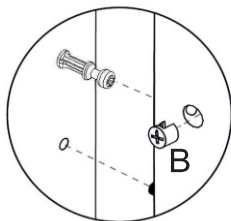
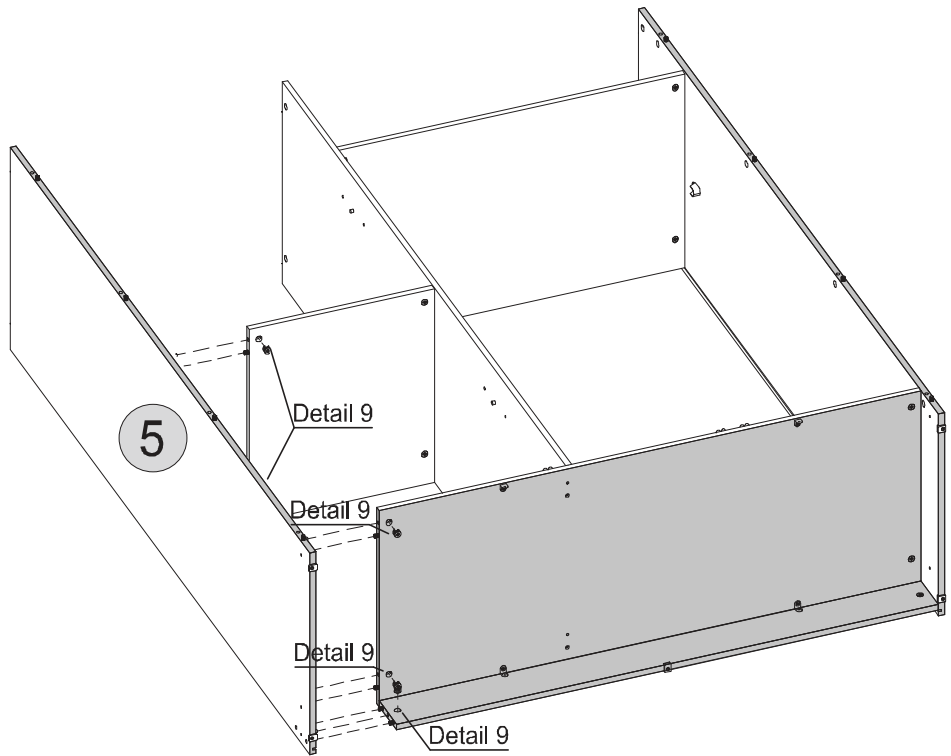
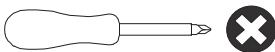

Detail 9

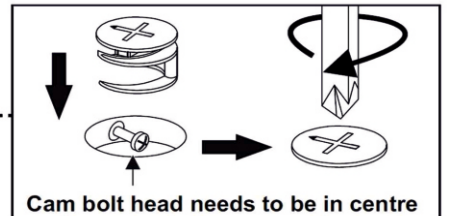

# STEP 15

## PARTS REQUIRED

1 - TOP PANEL x1

## HARDWARE REQUIRED

A  06

E  03

F  06

## TOOLS REQUIRED

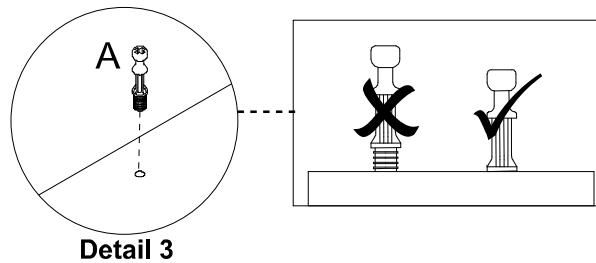
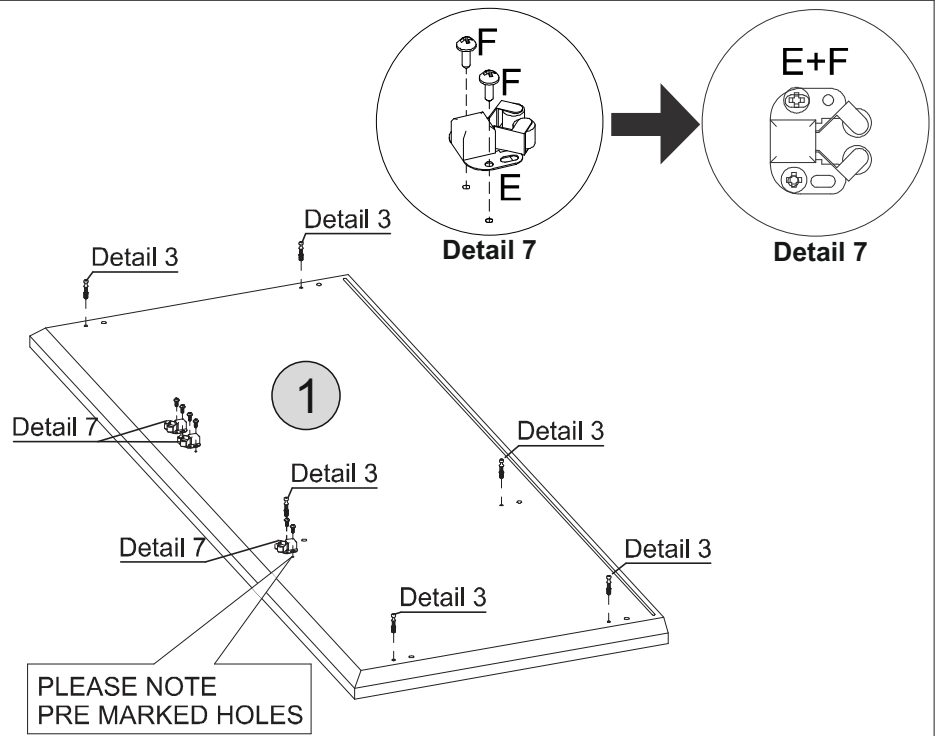
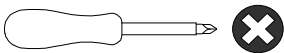

# STEP 16

## PARTS REQUIRED

1 - TOP PANEL x1

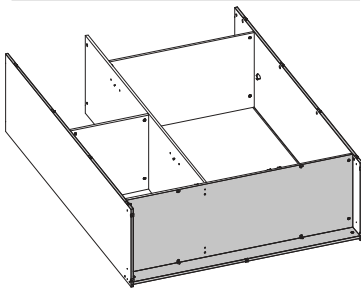

## HARDWARE REQUIRED

B  06

L  02

## TOOLS REQUIRED

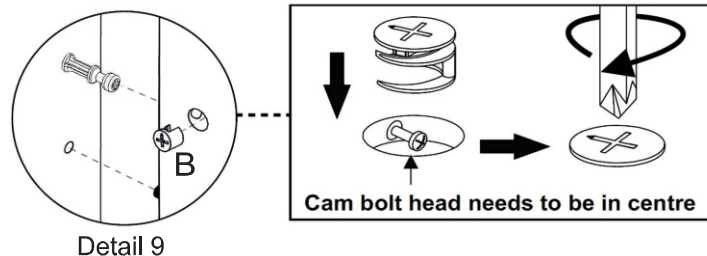
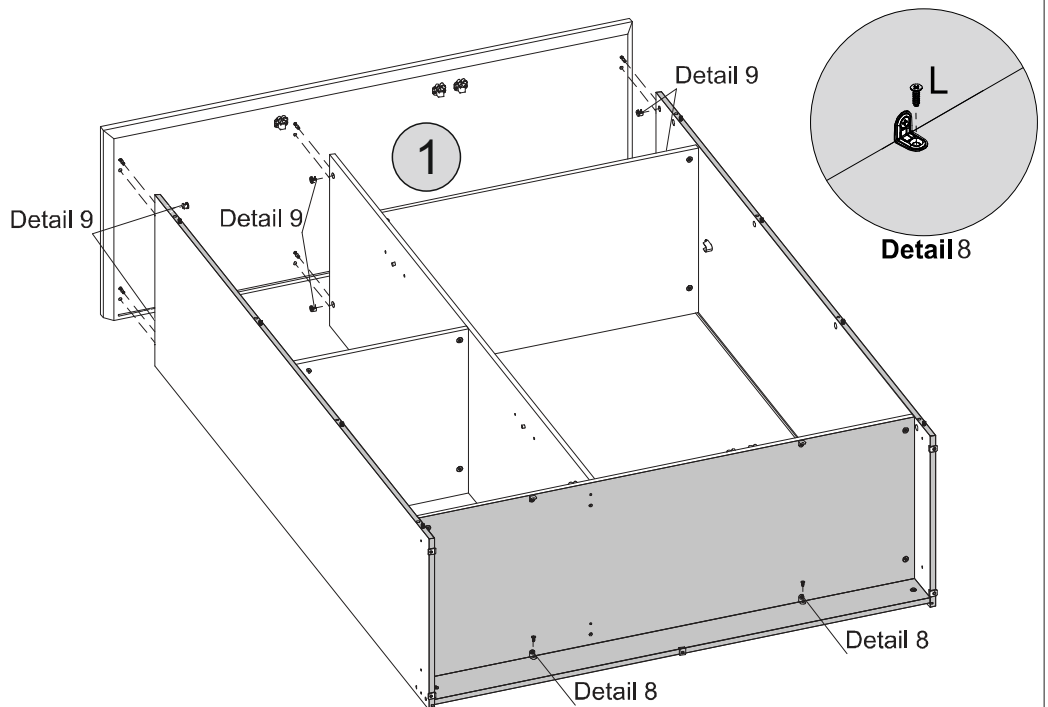
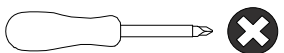

# STEP 17

## PARTS REQUIRED

9- LEFT FRONT UPRIGHT x1

10- RIGHT FRONT UPRIGHT x1

## HARDWARE REQUIRED

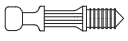
A  10

## TOOLS REQUIRED

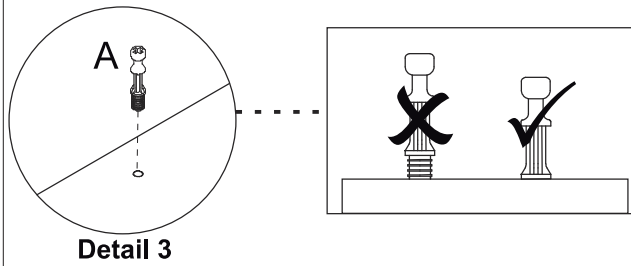
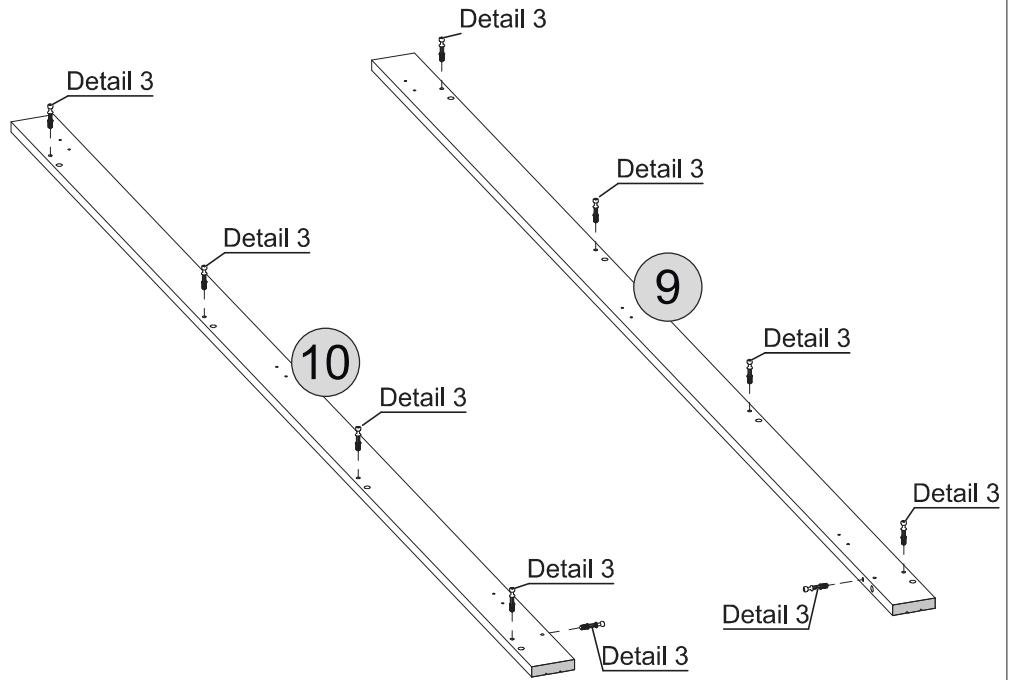
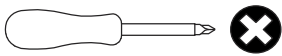

# STEP 18

## PARTS REQUIRED

9- LEFT FRONT UPRIGHT x1

10- RIGHT FRONT UPRIGHT x1

## HARDWARE REQUIRED

L  12

V  06

## TOOLS REQUIRED

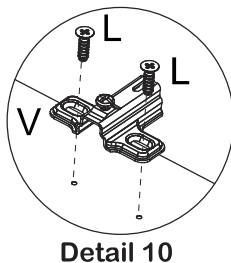
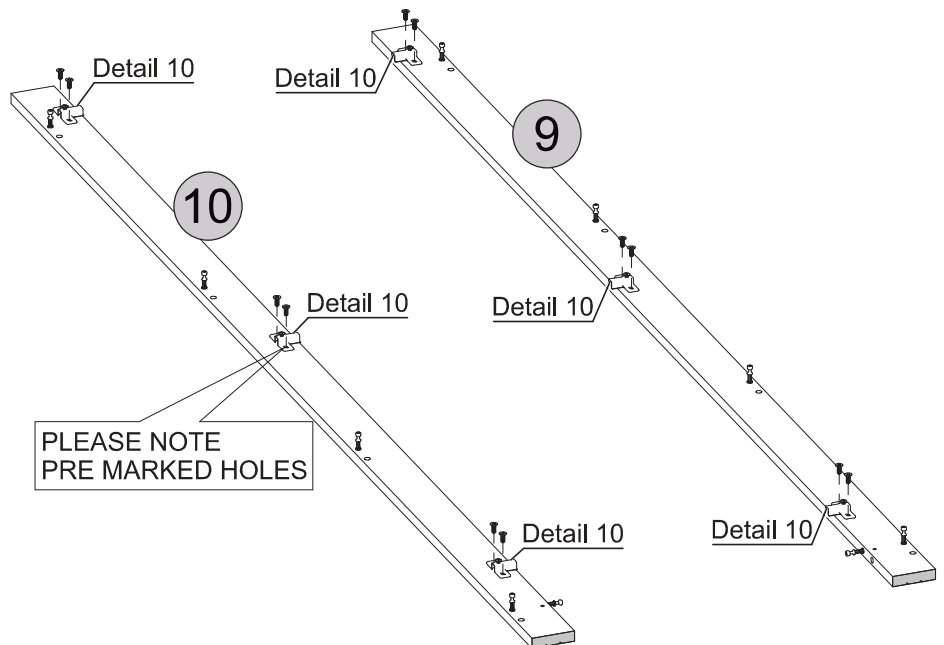
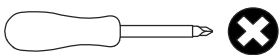



# STEP 19

**PARTS REQUIRED**

9 - LEFT FRONT UPRIGHT x1

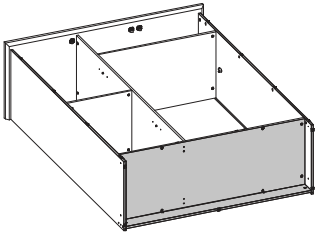

**HARDWARE REQUIRED**

B  04

**TOOLS REQUIRED**

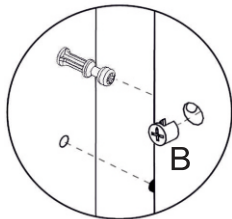
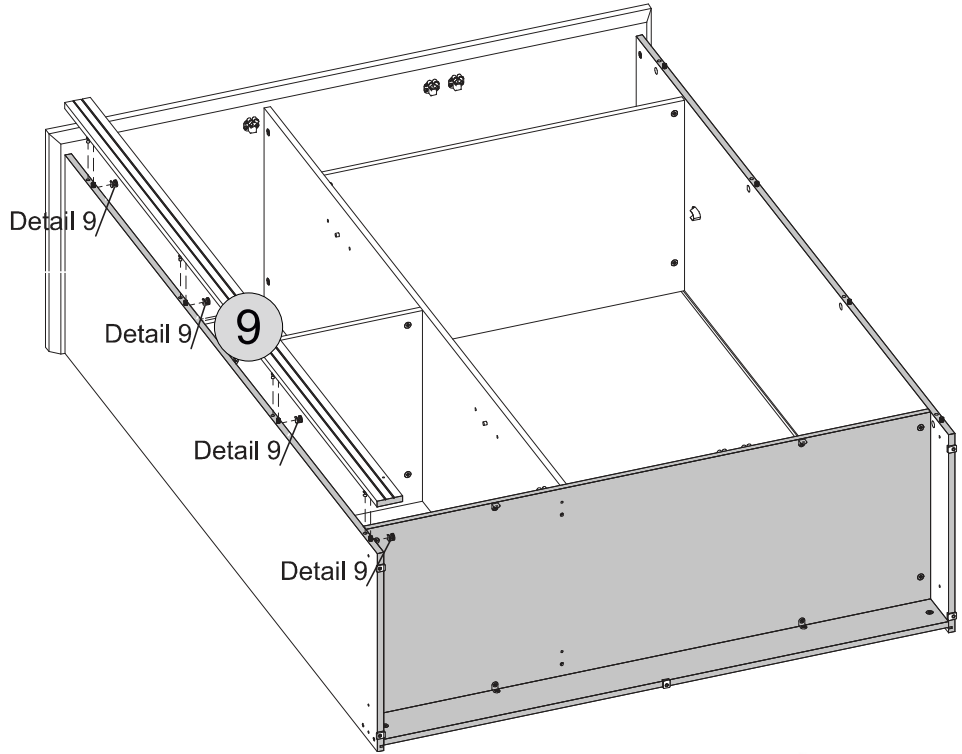
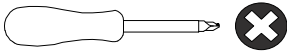

Detail 9

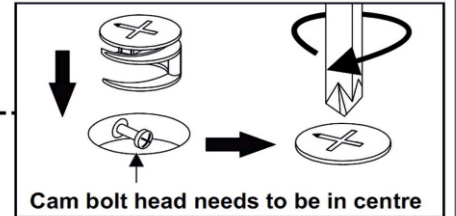

# STEP 20

**PARTS REQUIRED**

4 - CROSSBEAM x1

10- RIGHT FRONT UPRIGHT x1

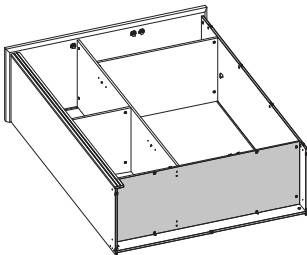

**HARDWARE REQUIRED**

B  06

L  02

**TOOLS REQUIRED**

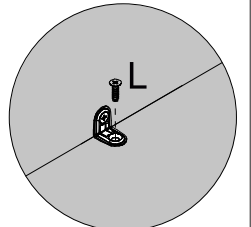
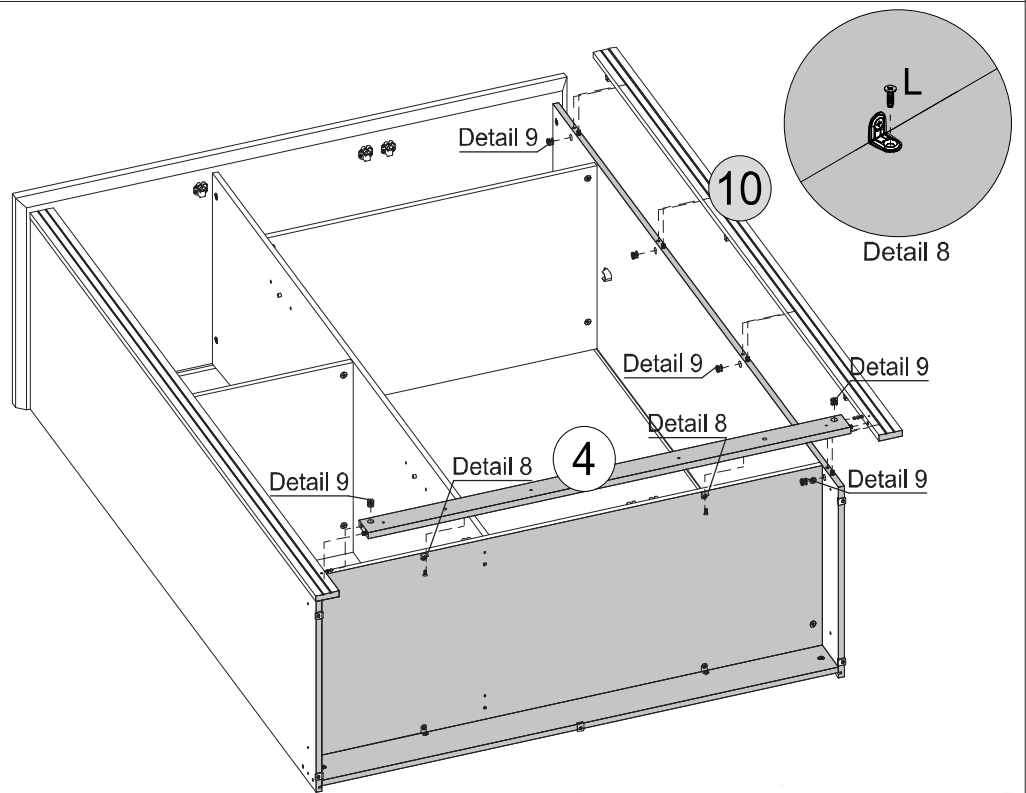
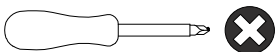

Detail 8

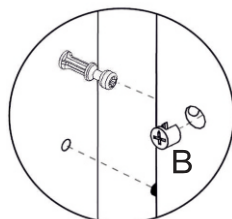

Detail 9

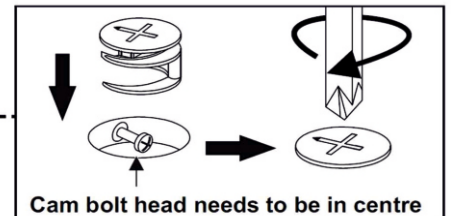

# STEP 21

**PARTS REQUIRED**

12- SIDE PLINTH x2

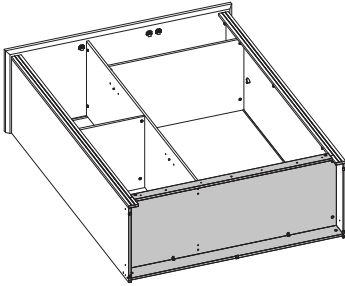

**HARDWARE REQUIRED**

G  04

**TOOLS REQUIRED**

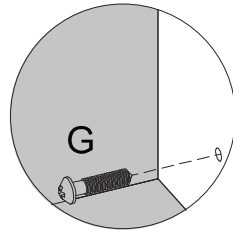
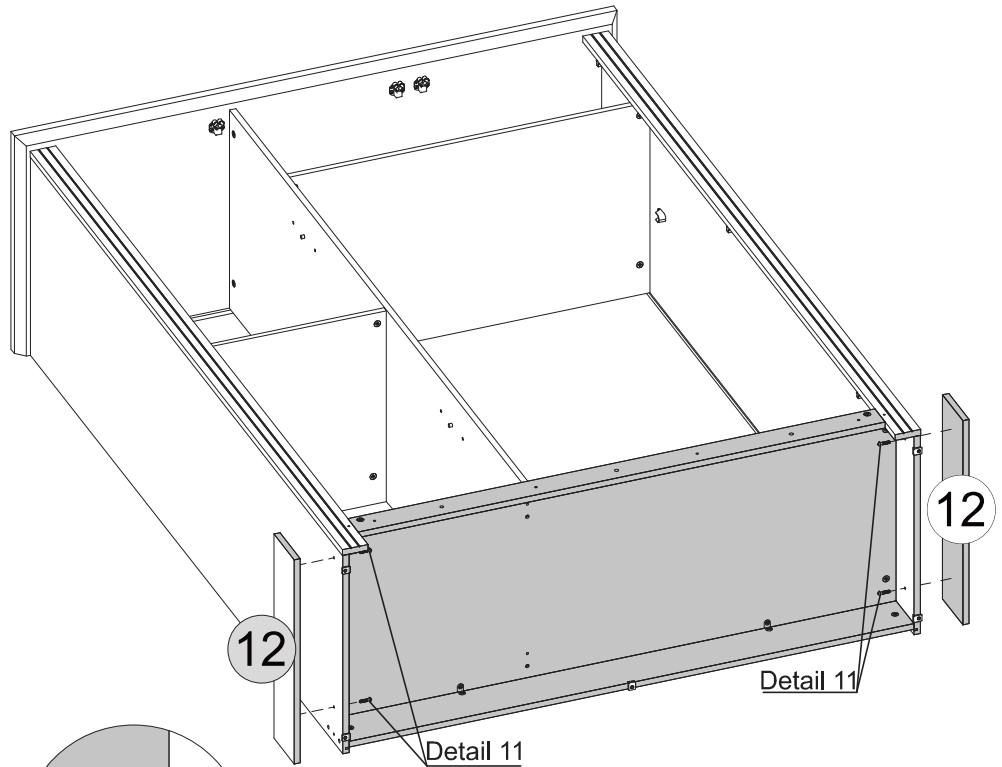
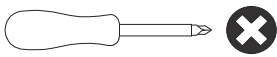

Detail 11

# STEP 22

**PARTS REQUIRED**

6- FRONT PLINTH x1

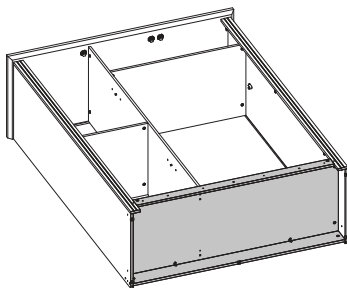

**HARDWARE REQUIRED**

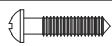
G  06

**TOOLS REQUIRED**

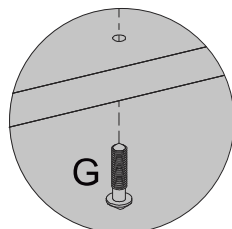
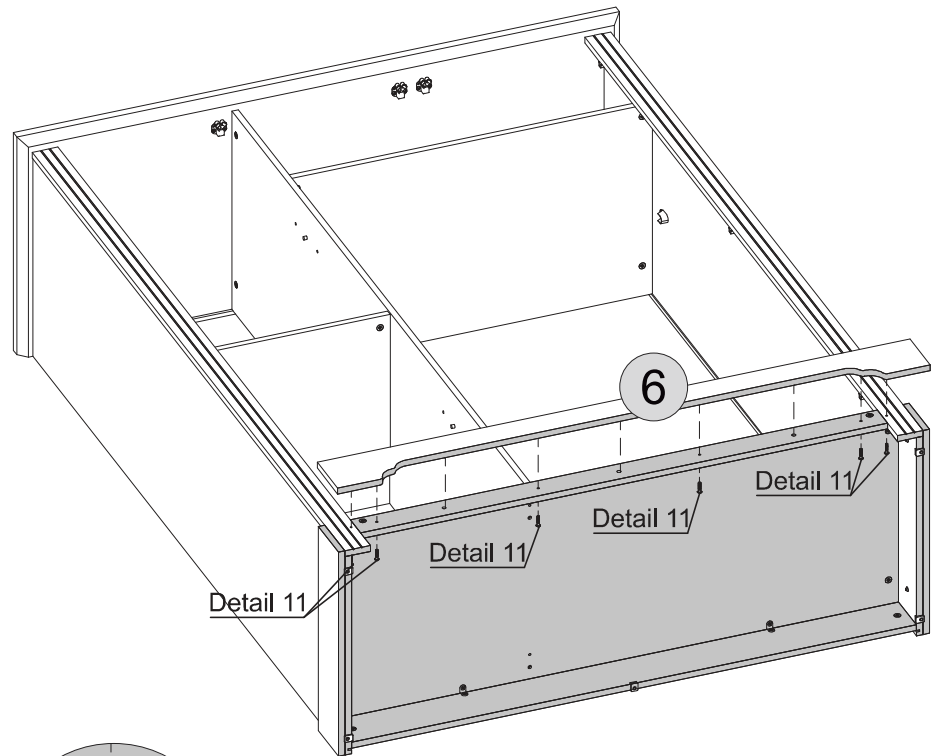
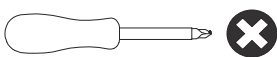

Detail 11

# STEP 23

## PARTS REQUIRED

11- BACK PANEL x2

17 -LARGE BACK PANEL x1

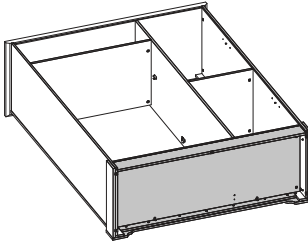

## HARDWARE REQUIRED

A1  01

## TOOLS REQUIRED

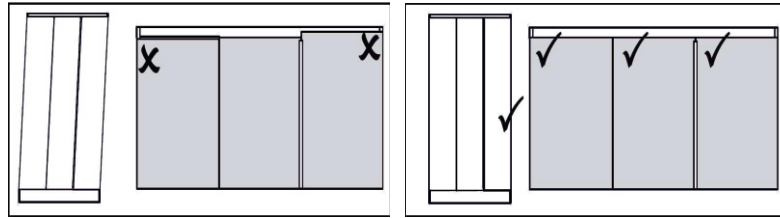

\* For your future reference  
Order Number should be here

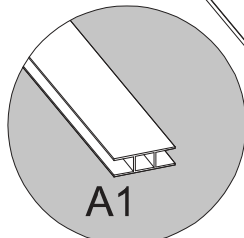
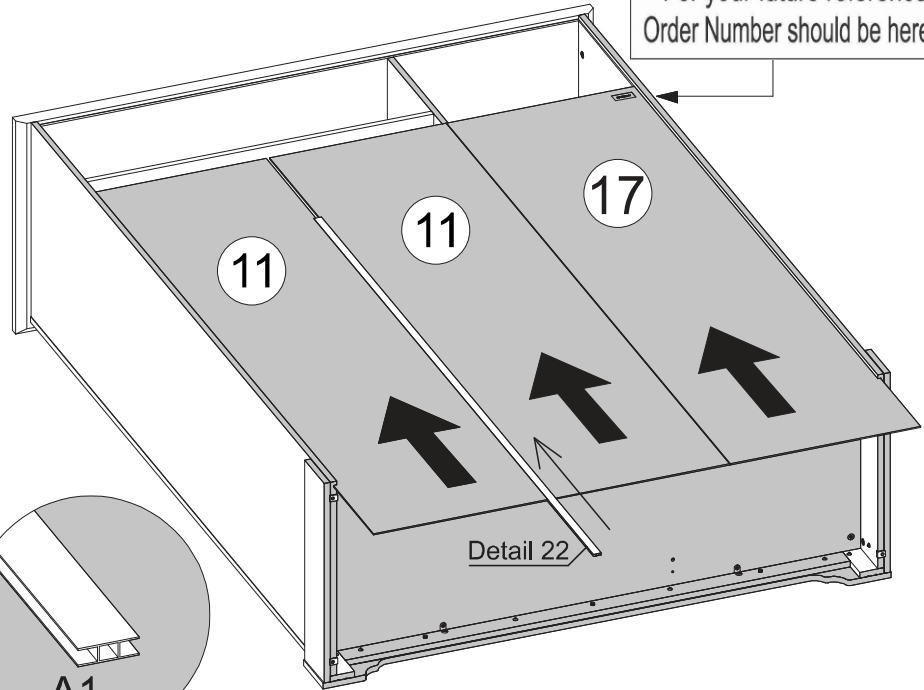

Detail 22

# STEP 24

## PARTS REQUIRED

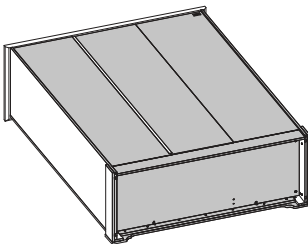

## HARDWARE REQUIRED

H  30

N  24

P  24

U  12

## TOOLS REQUIRED

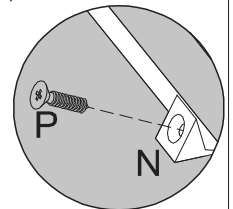
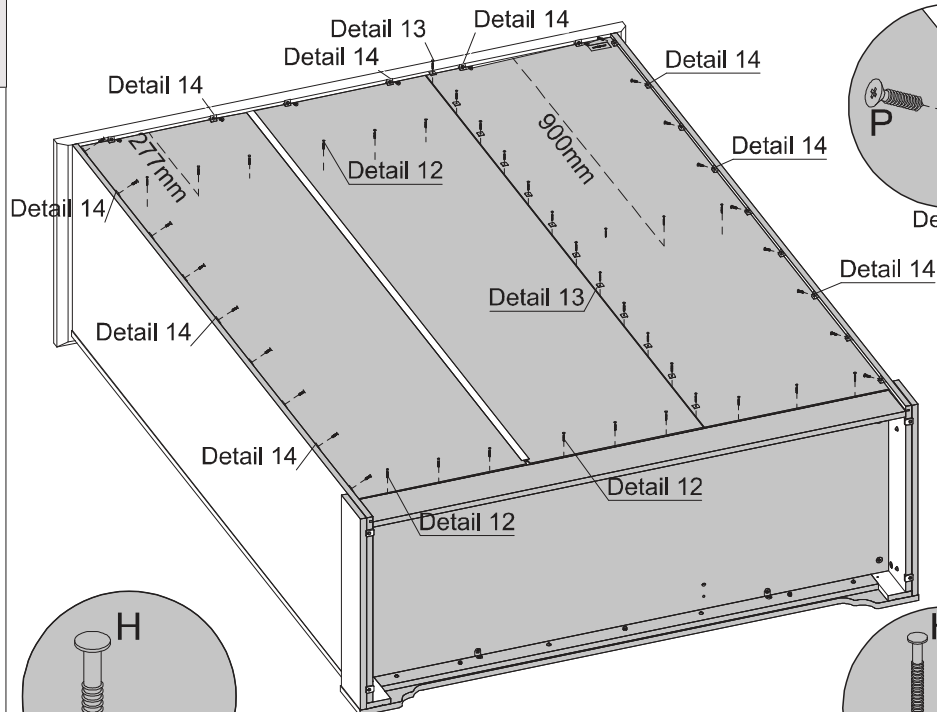
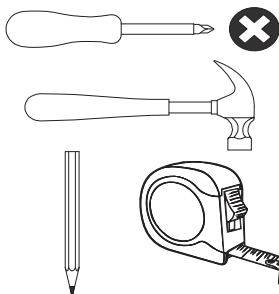

Detail 14

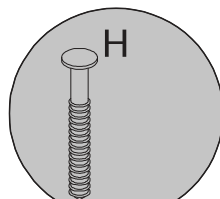

Detail 12

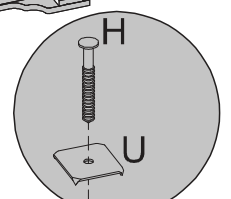

Detail 13

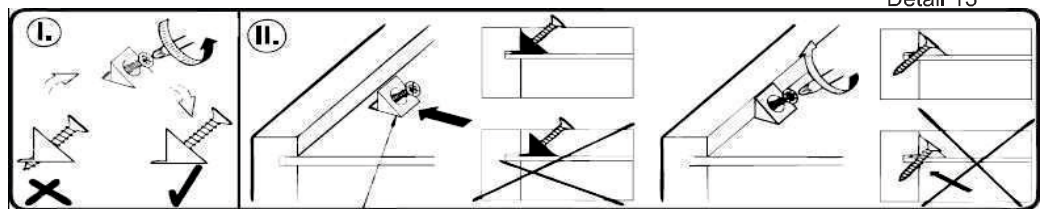

# STEP 25

## PARTS REQUIRED

15 - ADJUSTABLE SHELF x2

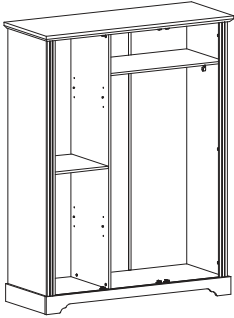

## HARDWARE REQUIRED

K		18
Z		01

## TOOLS REQUIRED

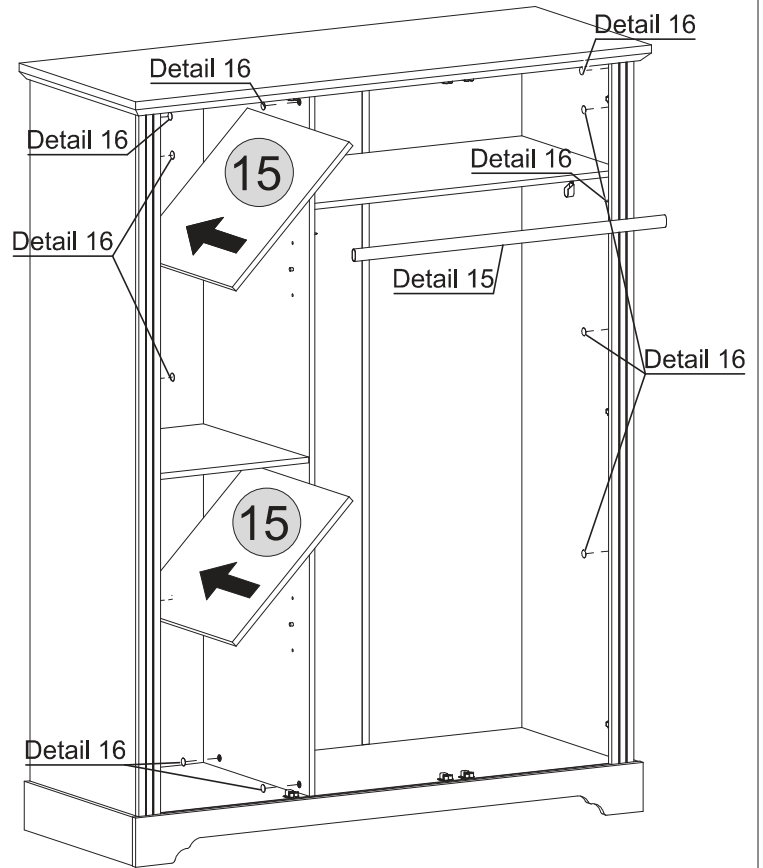
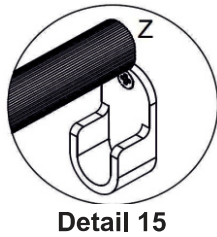
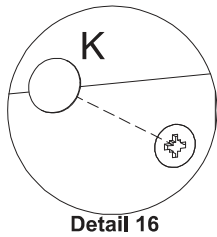

# STEP 26

## PARTS REQUIRED

13 - DOOR x2

## HARDWARE REQUIRED

E		04
F		08
L		12
W		06

## TOOLS REQUIRED

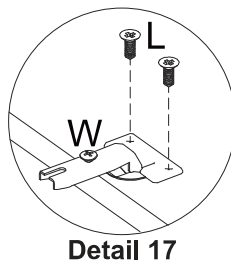
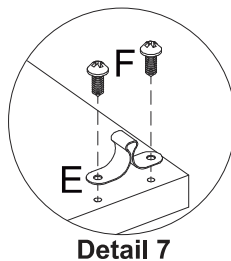
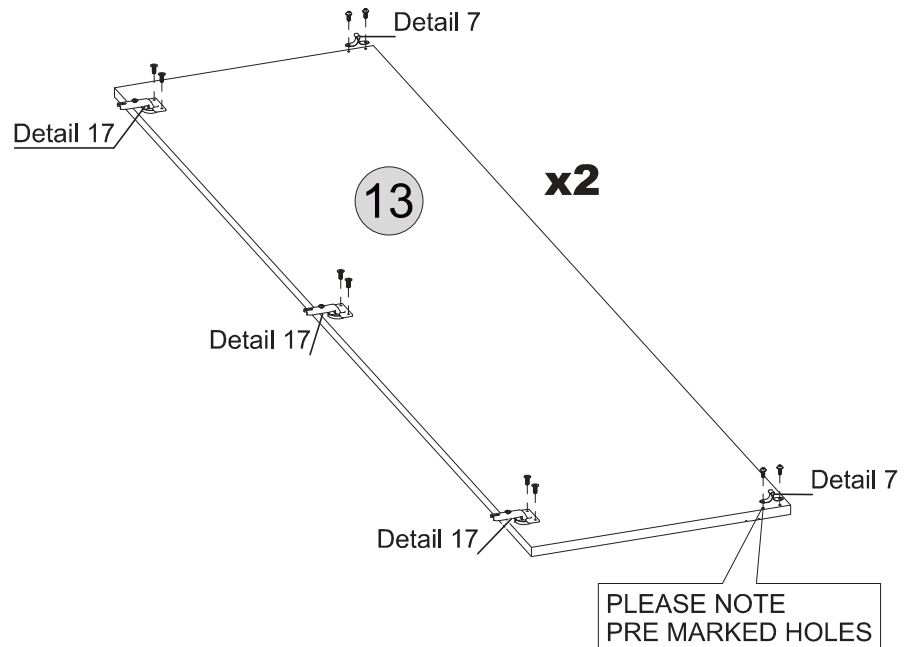
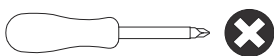

# STEP 27

## PARTS REQUIRED

13 - DOOR x2

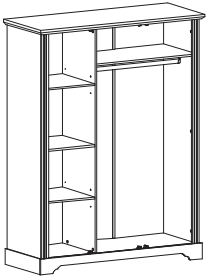

## HARDWARE REQUIRED

## TOOLS REQUIRED

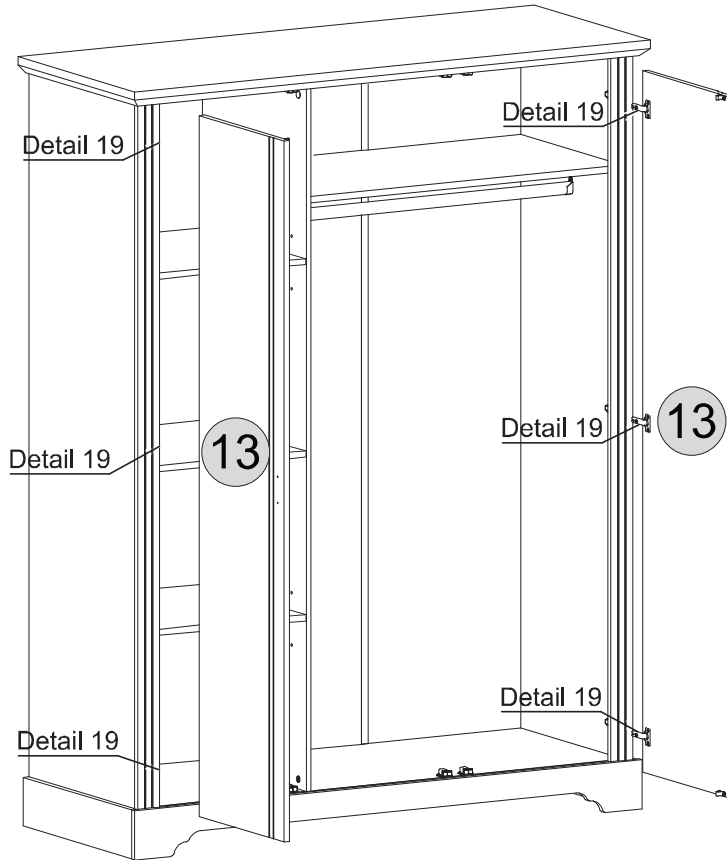
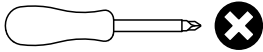

# STEP 28

## PARTS REQUIRED

13 - DOOR x1

## HARDWARE REQUIRED

E 02

F 04

L 06

Y 03

## TOOLS REQUIRED

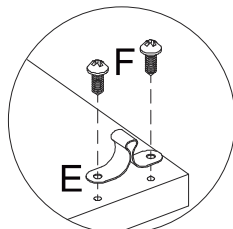
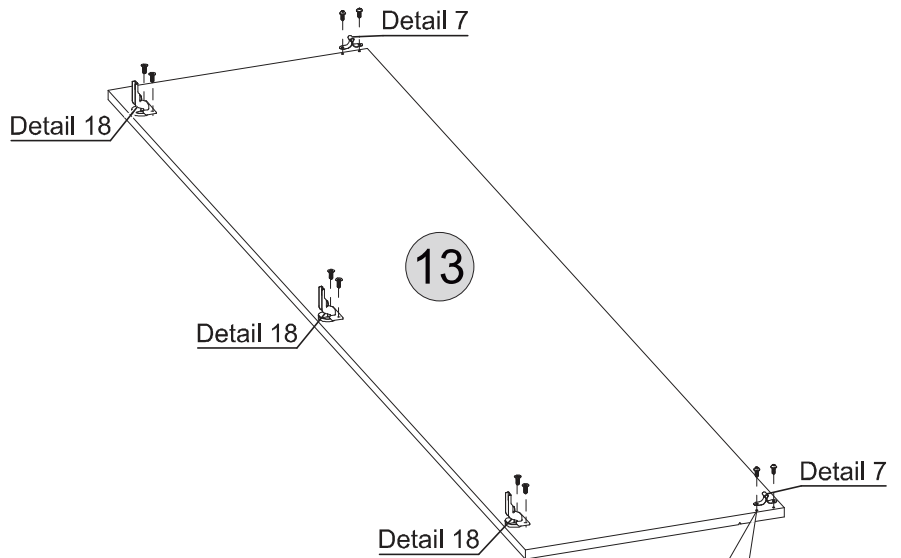
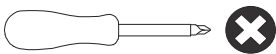

Detail 7

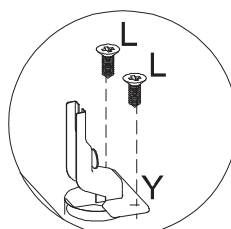

Detail 18

# STEP 29

**PARTS REQUIRED**

13- DOOR x1

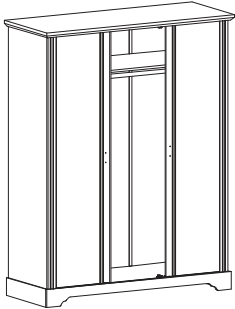

**HARDWARE REQUIRED**

**TOOLS REQUIRED**

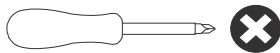

**TIP**  
If desired, after assembly use an alcohol cleaner to erase the number printed on the parts.

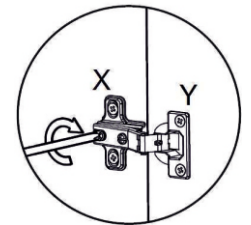
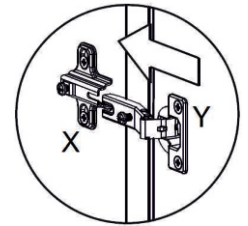
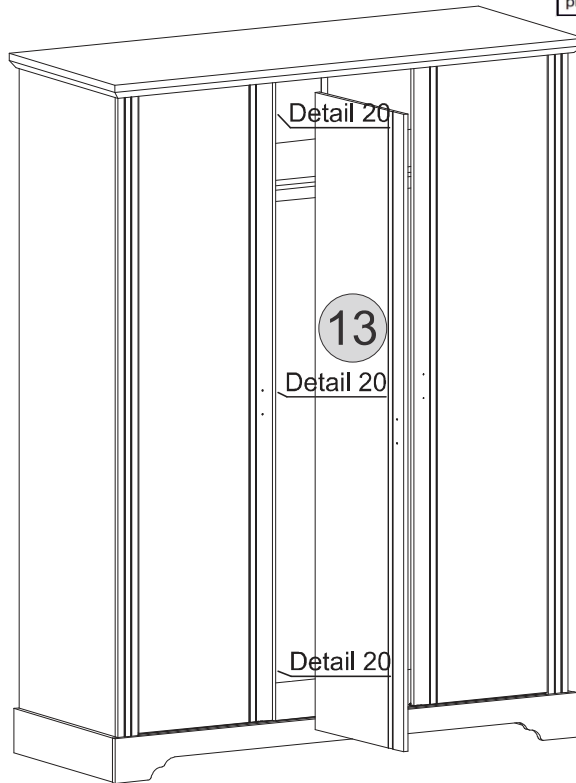

Detail 20

# STEP 30

**PARTS REQUIRED**

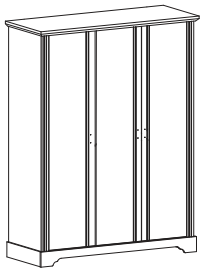

**HARDWARE REQUIRED**

T  03

**TOOLS REQUIRED**

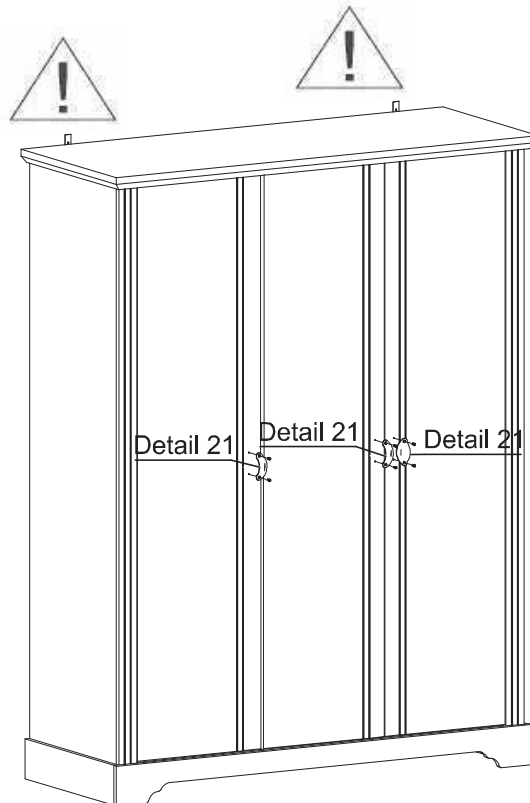

PLEASE NOTE PRE MARKED HOLES

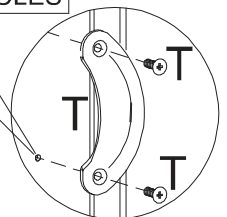

Detail 21

**!**  
SHOULD THE DOORS OF YOUR WARDROBE NOT APPEAR EVEN WHEN CLOSED THEY MAY NEED ADJUSTING. THIS CAN BE DONE AS FOLLOWS: LOOSEN SCREW (V,X) A LITTLE. BY TURNING SCREW (W,Y) EITHER CLOCKWISE OR ANTICLOCKWISE (IN OR OUT) THE HINGE CAN BE ADJUSTED AND THE DOOR CORRECTLY ALIGNED. IF MORE THAN ONE HINGE NEEDS ATTENTION PLEASE ADJUST ONE AT A TIME. IF IN DOUBT PLEASE SEEK PROFESSIONAL HELP.

Height Adjustment Internal Adjustment Depth Adjustment

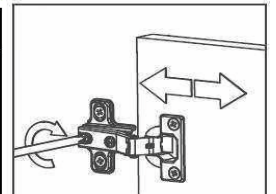
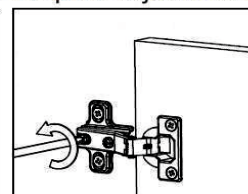
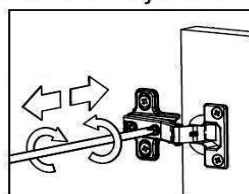
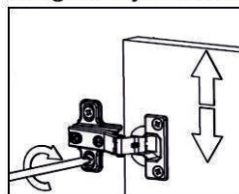

# STEP 31

## PARTS REQUIRED

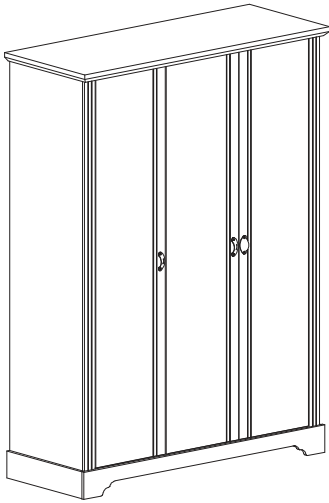

## HARDWARE REQUIRED

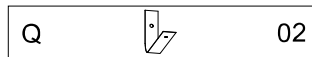
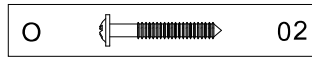
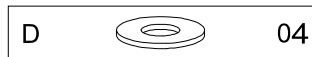

## TOOLS REQUIRED

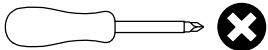

## WARNING

**Serious or fatal injuries can occur from furniture tipping over. To prevent the furniture from tipping over we recommend that it is permanently fixed to the wall.**

Wall fixings are not supplied with this product as different wall materials require different types of fixing devices. Please make sure you use fixings suitable for the walls in your home.

