

# GREY TOLEDO 2 DOOR WARDROBE ASSEMBLY INSTRUCTIONS

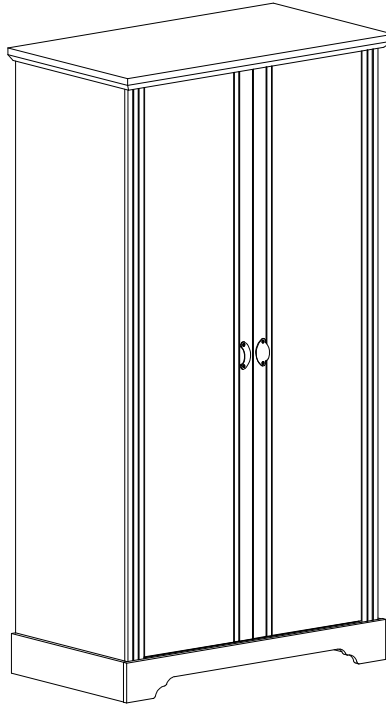

**IMPORTANT  
FOR DOMESTIC USE ONLY  
PLEASE READ BEFORE YOU CONTINUE FURTHER**

## CARE AND MAINTENANCE

After unpacking this product please keep the original packaging in case it needs to be returned for any reason.

- Please ensure all fittings and parts are present before commencing with assembly.
- Never drag or push products as this could cause damage to the joints making it inferior.
- We strongly recommend that you keep children away from your work area.
- We recommend that you lay a blanket or sheet on the floor to avoid damage to both your floor and the product.
- Assemble this product as close to its final position as possible.
- Do not place this product next to a radiator or in direct sunlight.
- Do not drag or push items across your high gloss furniture as this may cause the surface to scratch
- Wood is a natural product and may expand if subjected to damp and may shrink or crack if subjected to heat. Therefore it is recommended that room temperature is maintained, with no sudden temperature fluctuations.
- Make sure any spillage is wiped off immediately.
- Do not place hot or chilled items directly on to the surface, use a place mat or marking will occur.
- For general cleaning use a soft cotton or micro fibre cloth, and do not use detergents of any kind.
- From time to time it may be necessary to tighten fittings, regular inspections should be carried out.
- Do not place on a wet or damp floor as staining may occur to your floor.

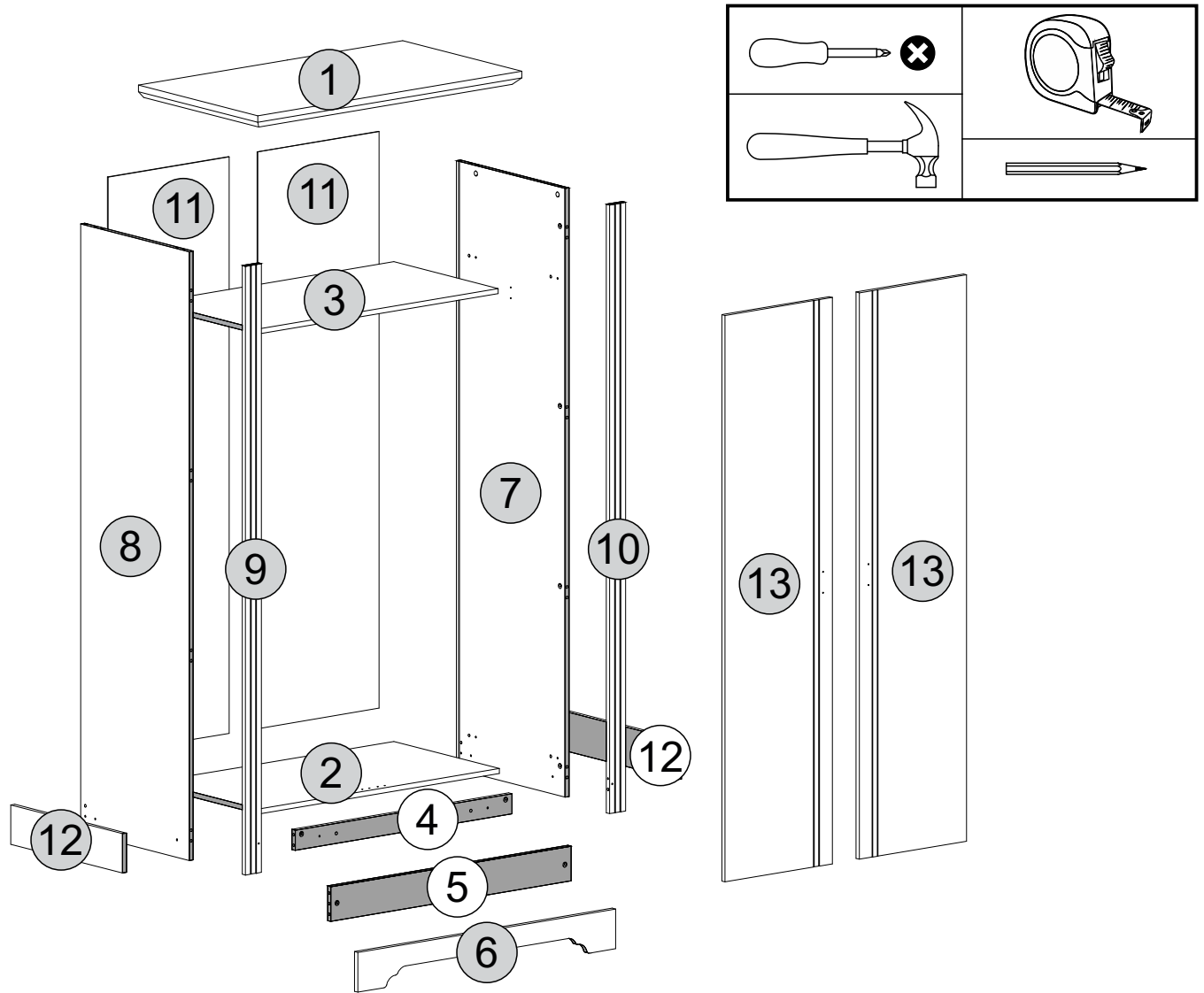











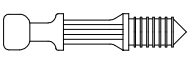
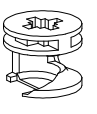
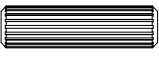
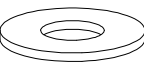
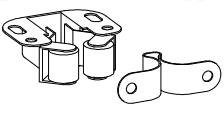

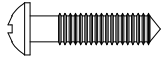
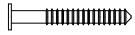
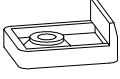
## PARTS LIST

***Please Note:***

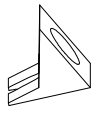
The below parts have all been stamped with the part number to help identify them during assembly.

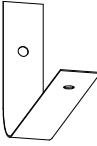
Part Number	Part Code	Part Description	Quantity	Carton
1	S100-101-125-HV1-01	Top Panel	1	1/3
2	S100-101-125-HV1-02	Base	1	1/3
3	S100-101-125-HV1-03	Shelf	1	1/3
4	S100-101-125-HV1-04	Crossbeam	1	1/3
5	S100-101-125-HV1-05	Back Baseboard	1	1/3
6	S100-101-125-HV1-06	Front Plinth	1	1/3
7	S100-101-125-HV1-07	Right Side Panel	1	2/3
8	S100-101-125-HV1-08	Left Side Panel	1	2/3
9	S100-101-125-HV1-09	Left Front Upright	1	2/3
10	S100-101-125-HV1-10	Right Front Upright	1	2/3
11	S100-101-125-HV1-11	Back Panel	2	2/3
12	S100-101-125-HV1-12	Side Plinth	2	2/3
13	S100-101-125-HV1-13	Door	2	3/3

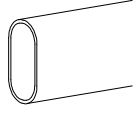
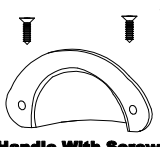
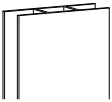
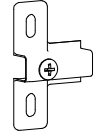
# FITTINGS LIST

<b>A</b> x 24  +1/2 <b>Cam Bolt 32xØ6mm</b>	<b>B</b> x 24  +1/2 <b>Can Nut Ø15 mm</b>	<b>C</b> x 28  +1/2 <b>Dowel Ø8 x 30 mm</b>	<b>D</b> x 2  +1/1 <b>Washer Ø16x7 mm</b>	<b>E</b> x 4  <b>Roller Clasp</b>
<b>F</b> x 16  +1/2 <b>Screw Ø3.5 x 12 mm</b>	<b>G</b> x 9  +1/1 <b>Screw Ø4 x 25 mm</b>	<b>H</b> x 16  +1/2 <b>Nail 10x10 Ringed 1,5x23 mm</b>	<b>I</b> x 4  +1/1 <b>Plastic Foot L 19x17x8mm Ø2mm</b>	<b>J</b> x 1  <b>Glue 10G</b>
<b>K</b> x 14  +1/2 <b>Hole Plugs 19mm</b>	<b>L</b> x 36  +1/2 <b>Screw Ø4 x 14 mm</b>	<b>M</b> x 4  <b>SUPPORT METALIC "L" 16x18mm</b>	<b>N</b> x 20  <b>TRIANGLE SUPPORT ANGLE</b>	<b>O</b> x 1  <b>Screw Ø3,5 x 30 mm</b>
<b>P</b> x 20  +1/2 <b>Screw Ø3 x 16 mm</b>	<b>Q</b> x 1  <b>Strap 200x20x1mm</b>	<b>R</b> x 2  <b>Support Pipe Oblongo Metalic</b>	<b>S</b> x 1  <b>Pipe Oblongo 910x30x16x0,6mm</b>	<b>T</b> x 2  <b>Handle With Screws</b>
<b>U</b> x 1  <b>Profile H 1719mm</b>	<b>V</b> x 6  <b>HINGE SHIM 26mm H7</b>	<b>W</b> x 6  <b>HINGE 26mm 90°</b>		

## TIPS FOR FITTINGS CAM-LOCKS

WHEN FITTING CAM NUT. ENSURE STARTING POSITION IS CORRECT BEFORE YOU INSERT CONNECTING CAM BOLT TURN CLOCKWISE UNTIL SECURE

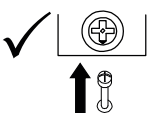

↑  
**CORRECT**

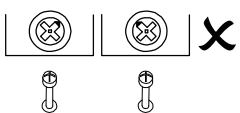

↓  
**WRONG**

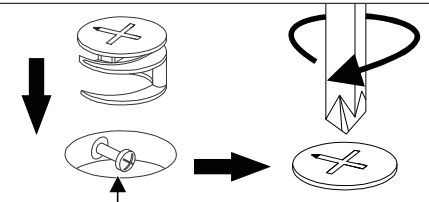

Cam bolt head needs to be in centre

### CAMBOLT

Tighten until shoulder in flush with panel. Do not overtighten or undertighten (see example beside)

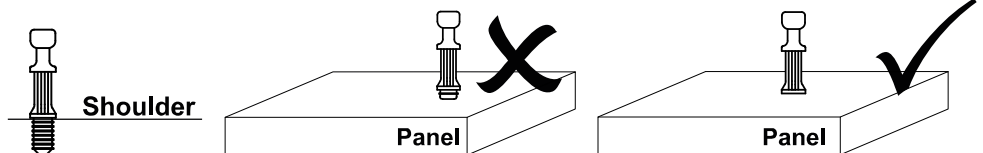

# STEP 1

## PARTS REQUIRED

7 - RIGHT SIDE PANEL x1

## HARDWARE REQUIRED

C  06

H  02

I  02

J  01

## TOOLS REQUIRED

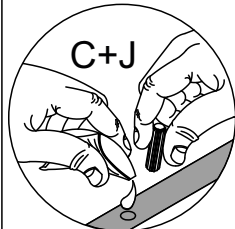
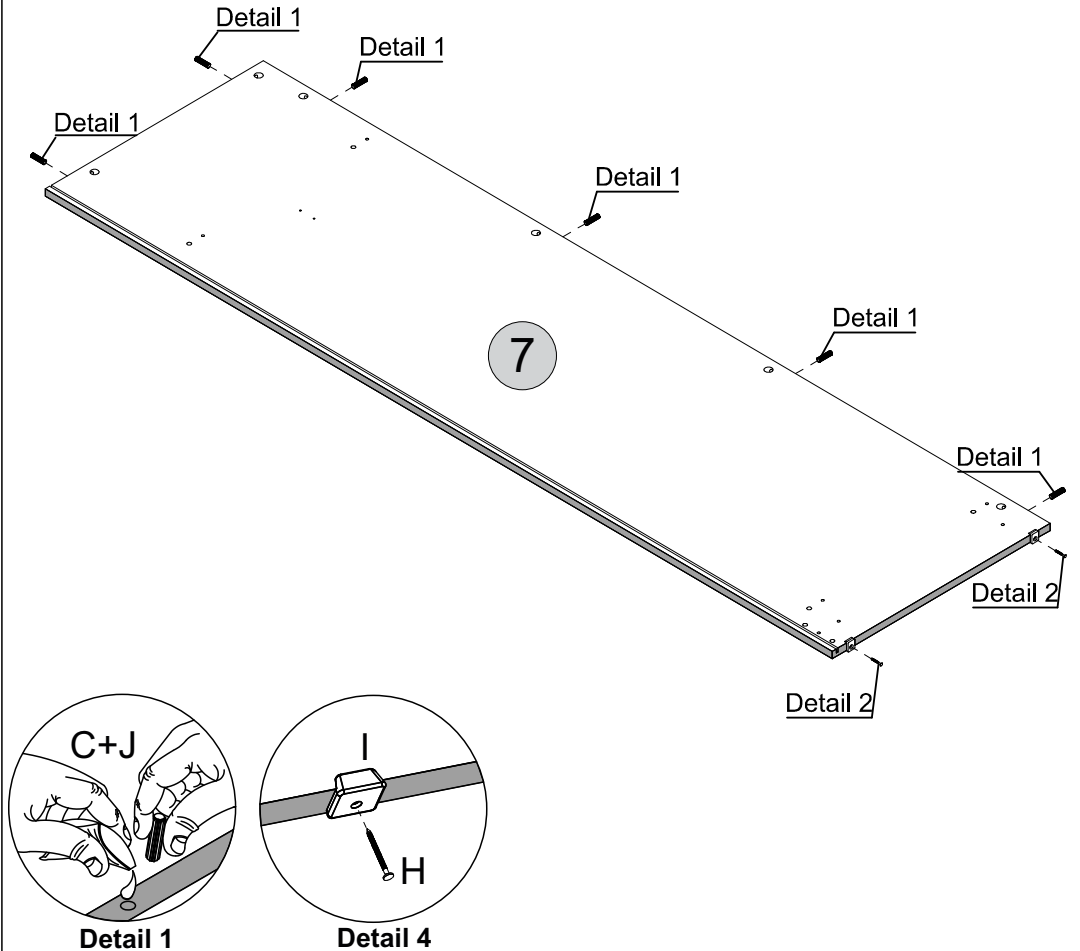
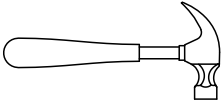

Detail 1

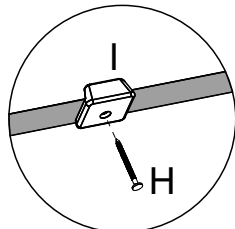

Detail 4

# STEP 2

## PARTS REQUIRED

7 - RIGHT SIDE PANEL x1

## HARDWARE REQUIRED

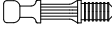
A  05

L  02

R  01

## TOOLS REQUIRED

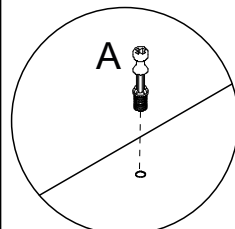
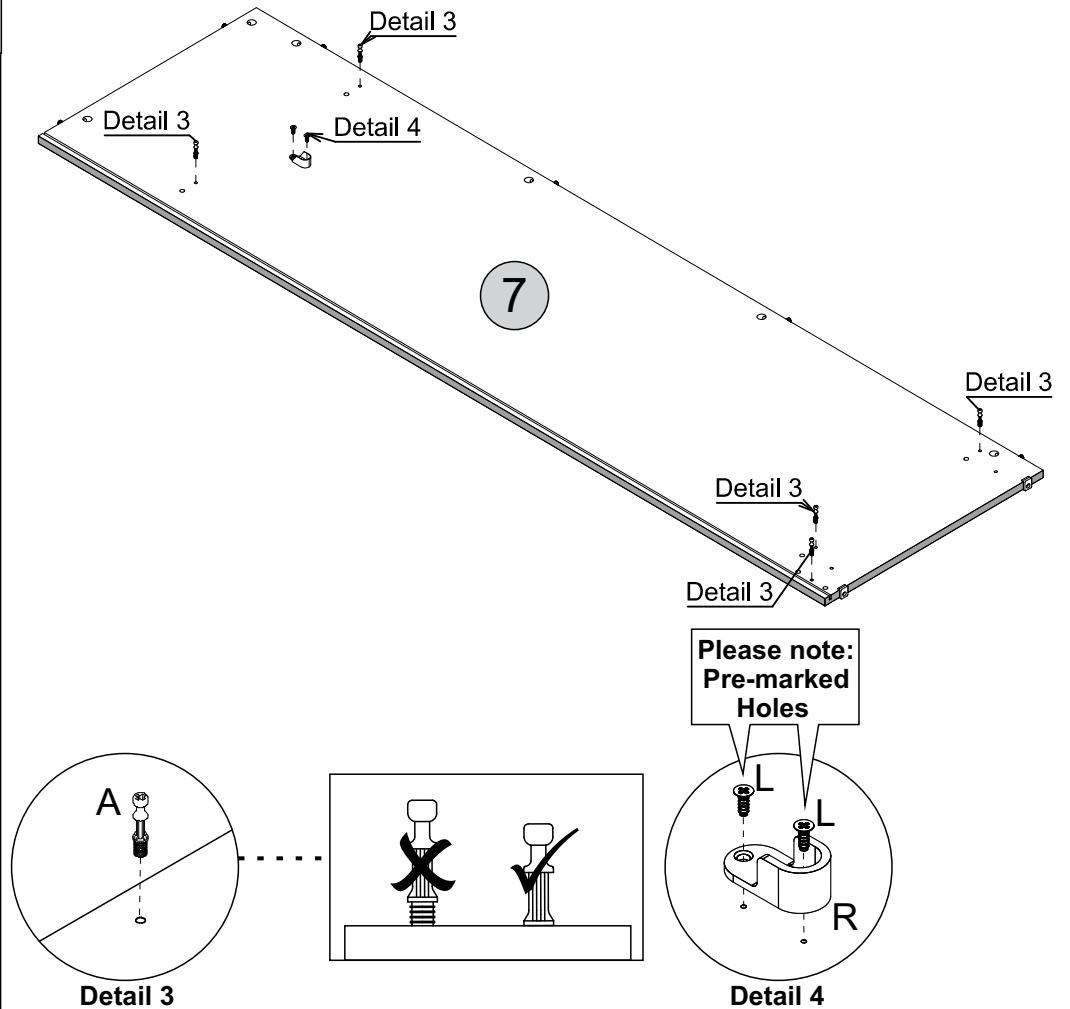
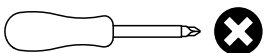

Detail 3

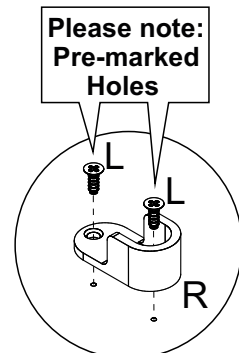
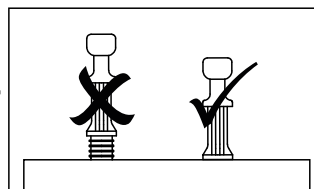

Detail 4

Please note:  
Pre-marked  
Holes

# STEP 3

## PARTS REQUIRED

8 - LEFT SIDE PANEL x1

## HARDWARE REQUIRED

C  06

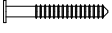
H  02

I  02

J  01

## TOOLS REQUIRED

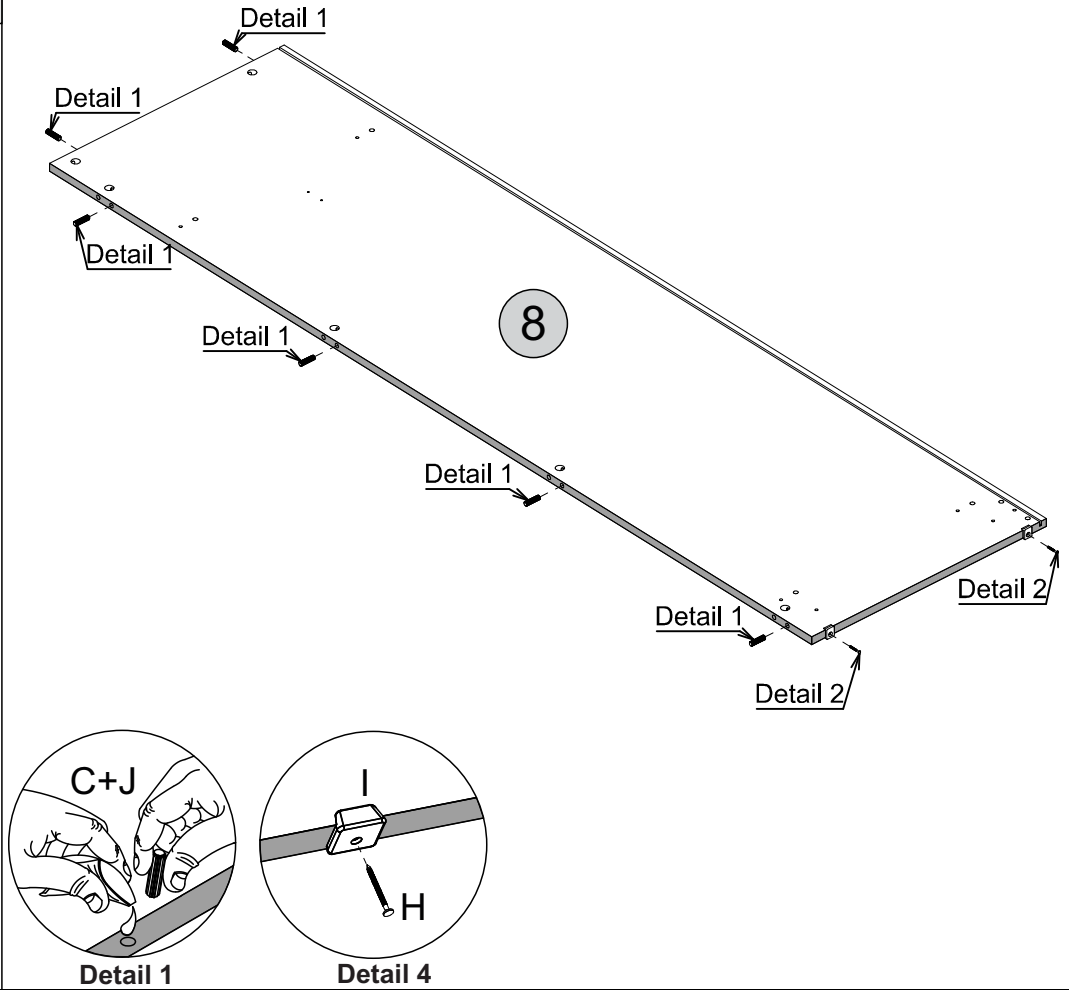
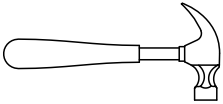



# STEP 4

## PARTS REQUIRED

8 - LEFT SIDE PANEL x1

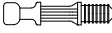
## HARDWARE REQUIRED

A  05

L  02

R  01

## TOOLS REQUIRED

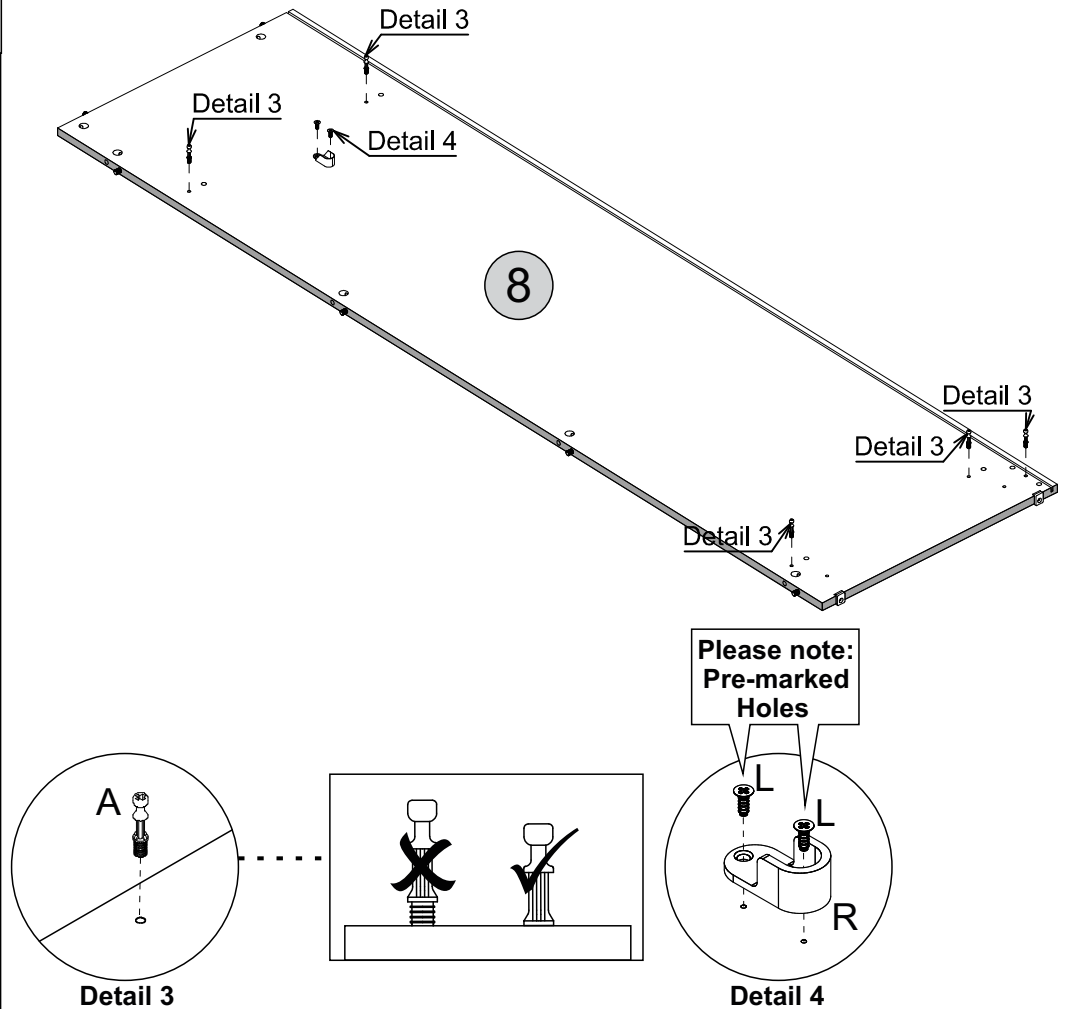
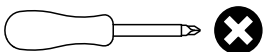

# STEP 5

## PARTS REQUIRED

2 - BASE x1

## HARDWARE REQUIRED

C  04

E  02

F  04

J  01

L  04

M  04

## TOOLS REQUIRED

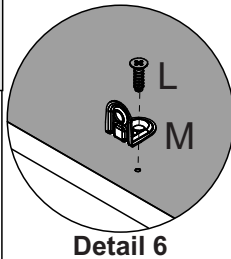
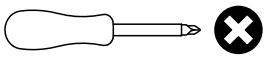

Detail 6

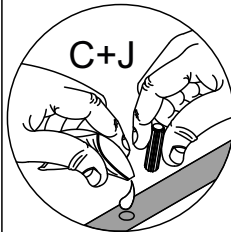
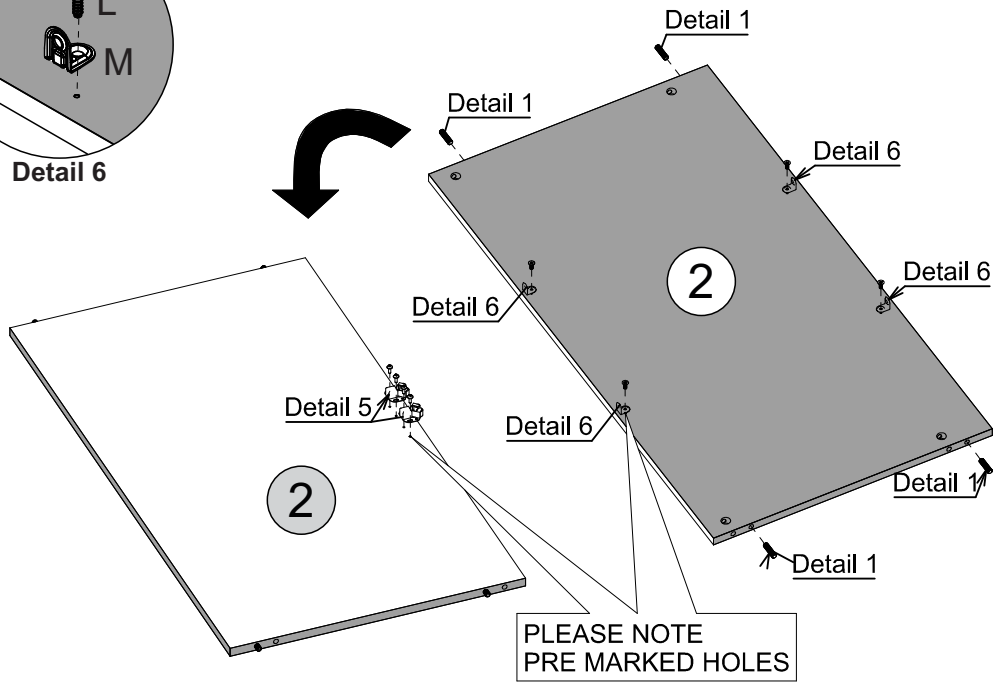

Detail 1

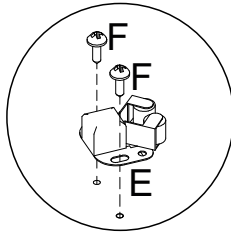

Detail 5

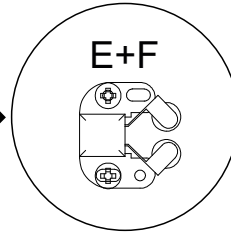

Detail 5

# STEP 6

## PARTS REQUIRED

3 - SHELF x1

4 - CROSSBEAM x1

5 - BASE BASEBOARD x1

6 - FRONT PLINTH x1

## HARDWARE REQUIRED

C  12

J  01

## TOOLS REQUIRED

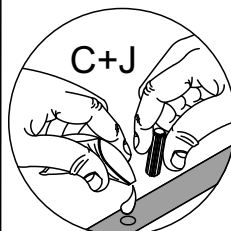
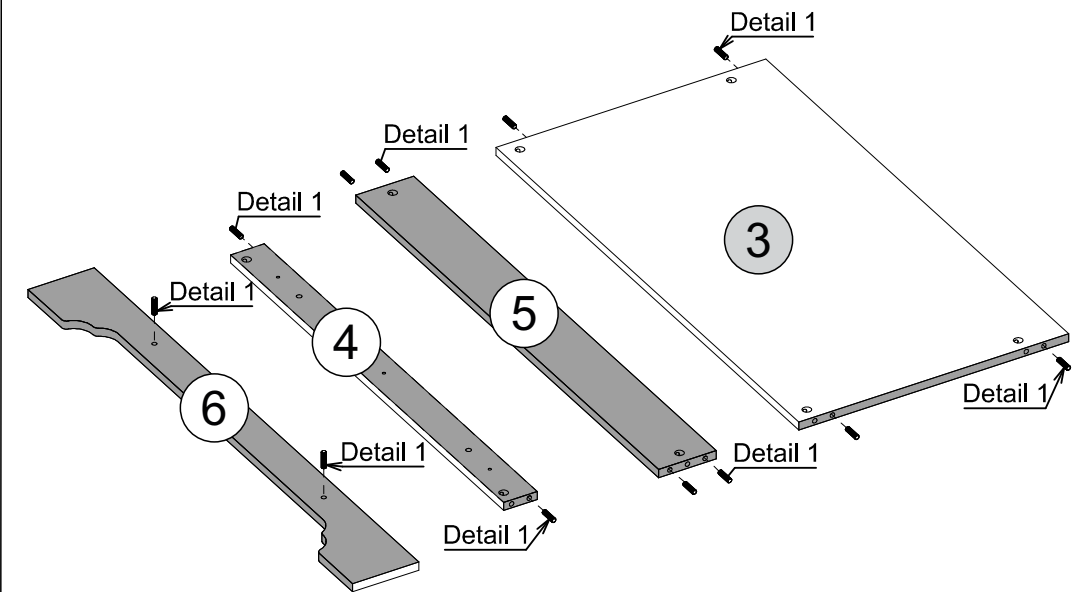

Detail 1

# STEP 7

## PARTS REQUIRED

- 2 - BASE x1
- 3 - SHELF x1
- 7 - RIGHT SIDE PANEL x1

## HARDWARE REQUIRED

- B  04

## TOOLS REQUIRED

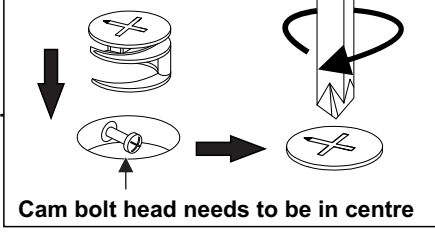
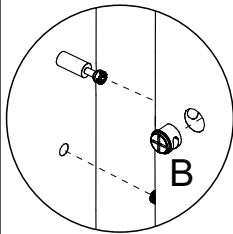
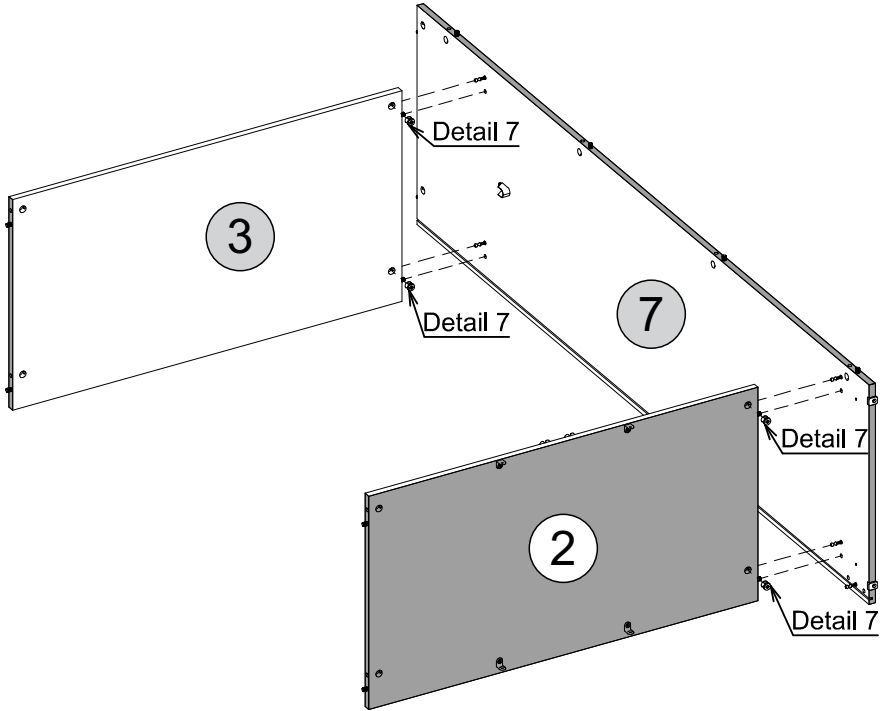
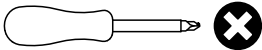

# STEP 8

## PARTS REQUIRED

- 5 - BACK BASEBOARD x1
- 8 - LEFT SIDE PANEL x1

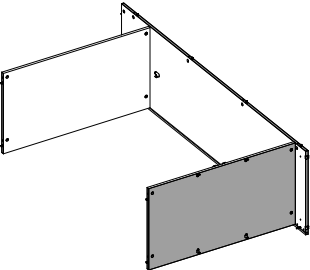

## HARDWARE REQUIRED

- B  06

## TOOLS REQUIRED

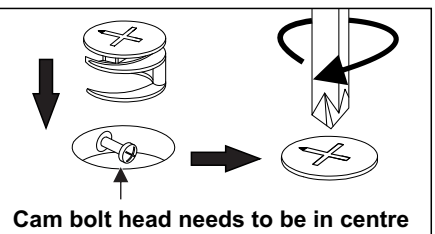
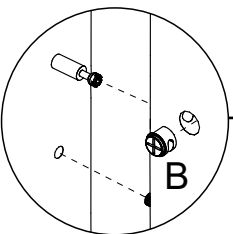
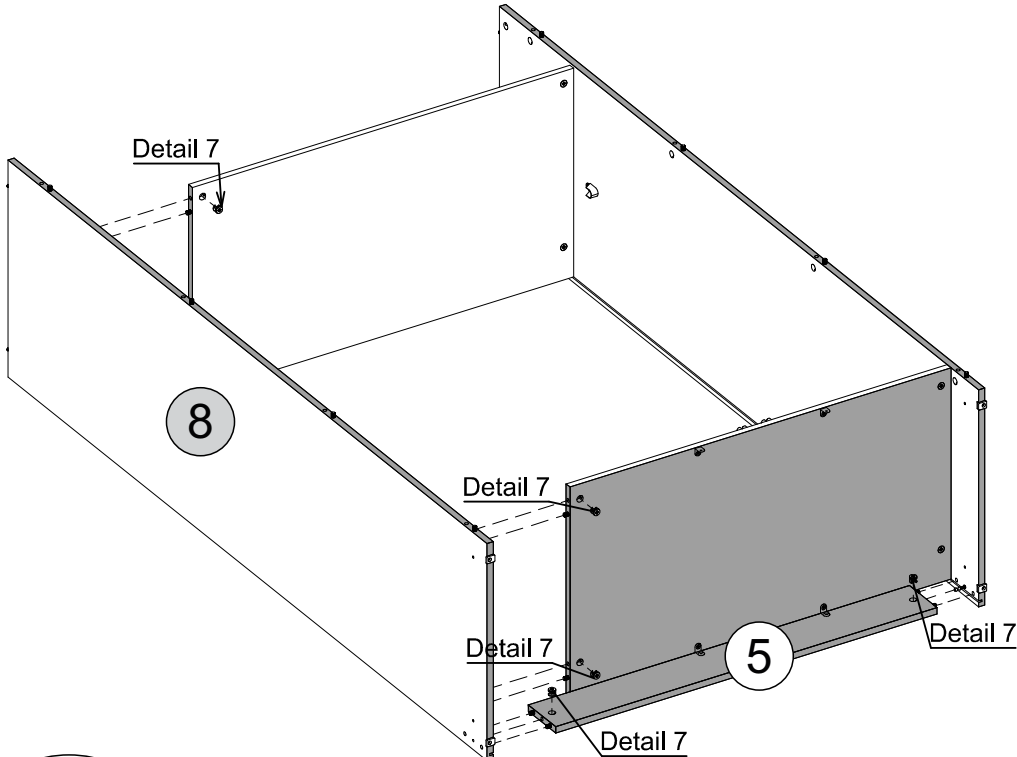
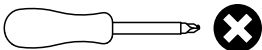



# STEP 9

## PARTS REQUIRED

1 - TOP PANEL x1

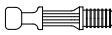
## HARDWARE REQUIRED

- A  04
- E  02
- F  04

## TOOLS REQUIRED

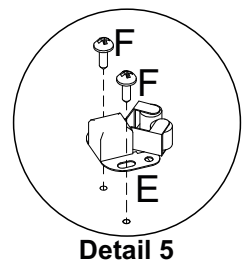
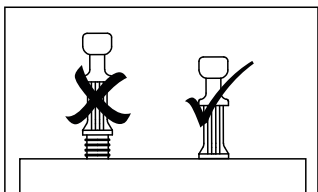
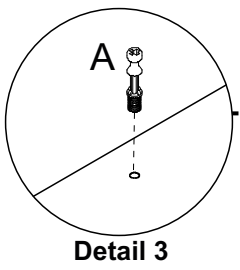
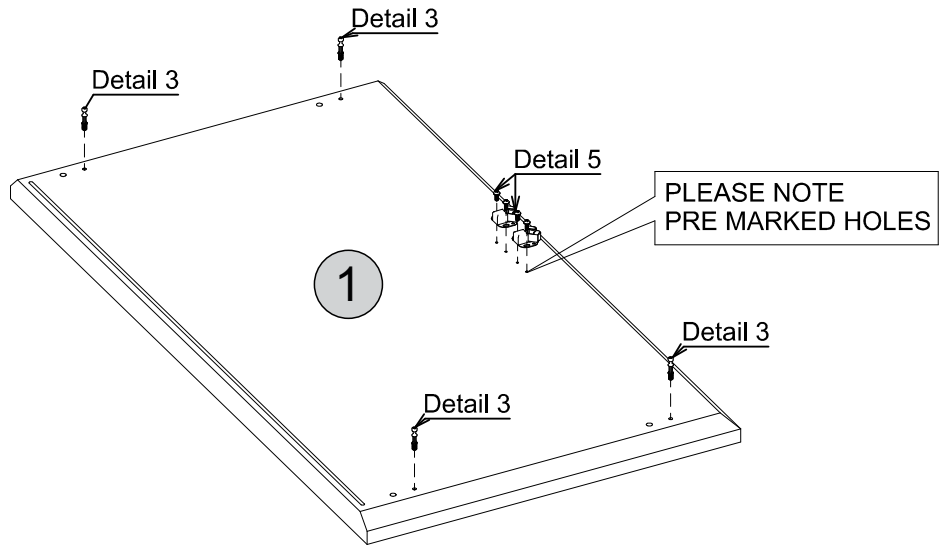
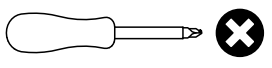



# STEP 10

## PARTS REQUIRED

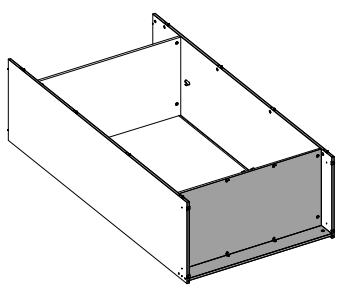
1 - TOP PANEL x1



## HARDWARE REQUIRED

- B  04
- L  02

## TOOLS REQUIRED

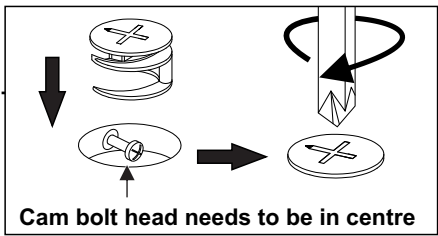
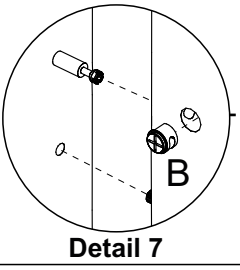
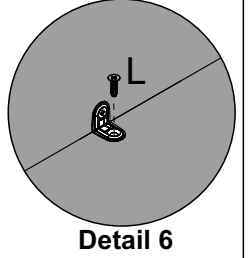
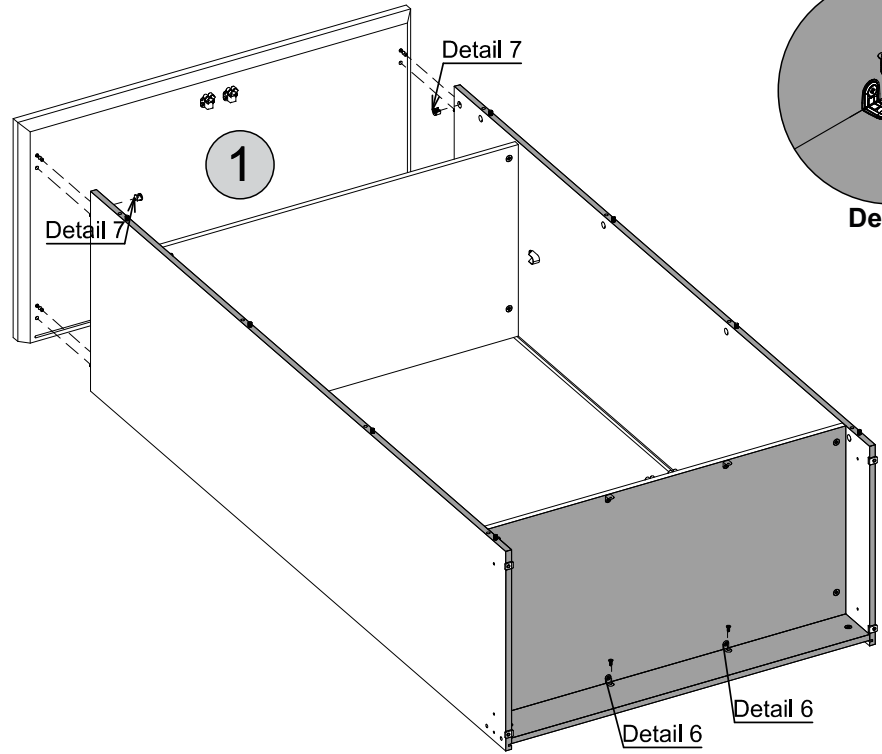
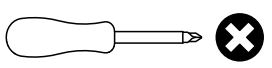



# STEP 11

## PARTS REQUIRED

9 - LEFT FRONT UPRIGHT x1

10- RIGHT FRONT UPRIGHT x1

## HARDWARE REQUIRED

A  10

## TOOLS REQUIRED

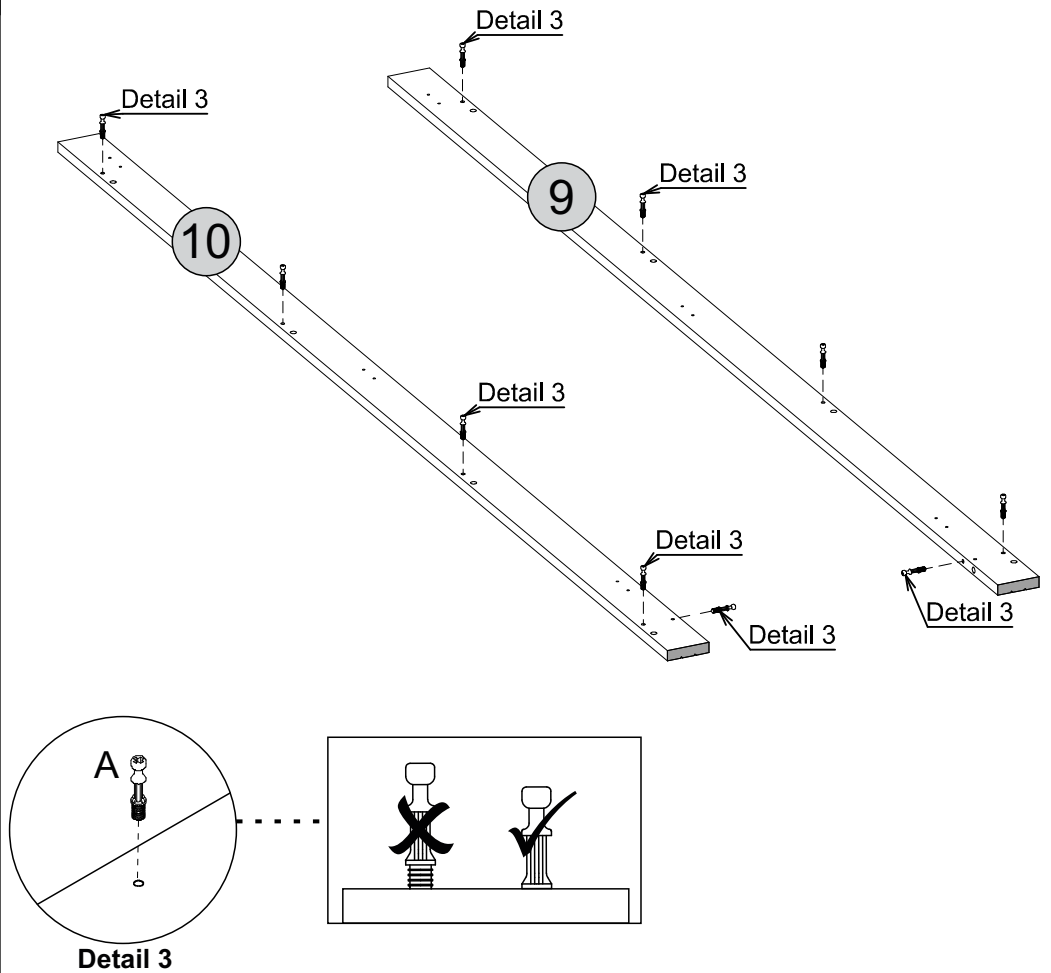
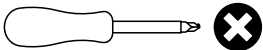

# STEP 12

## PARTS REQUIRED

9 - LEFT FRONT UPRIGHT x1

10- RIGHT FRONT UPRIGHT x1

## HARDWARE REQUIRED

L  12

V  06

## TOOLS REQUIRED

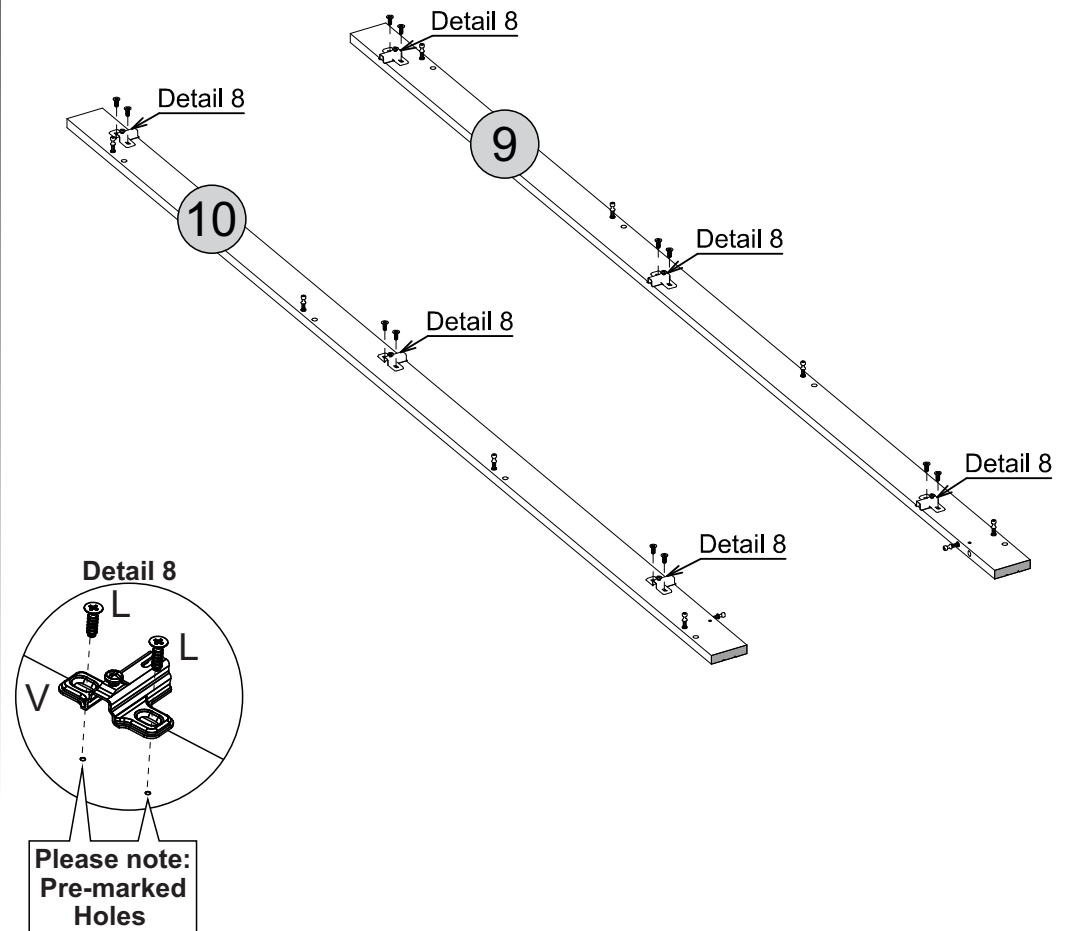
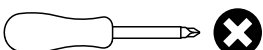

# STEP 13

## PARTS REQUIRED

9 - LEFT FRONT UPRIGHT x1

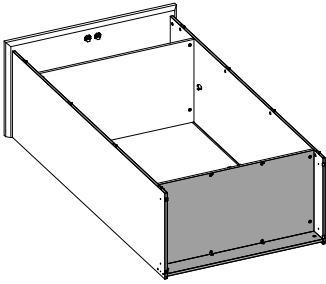

## HARDWARE REQUIRED

B  04

## TOOLS REQUIRED

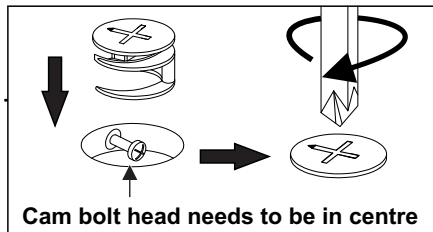
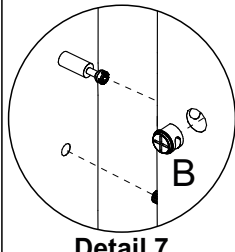
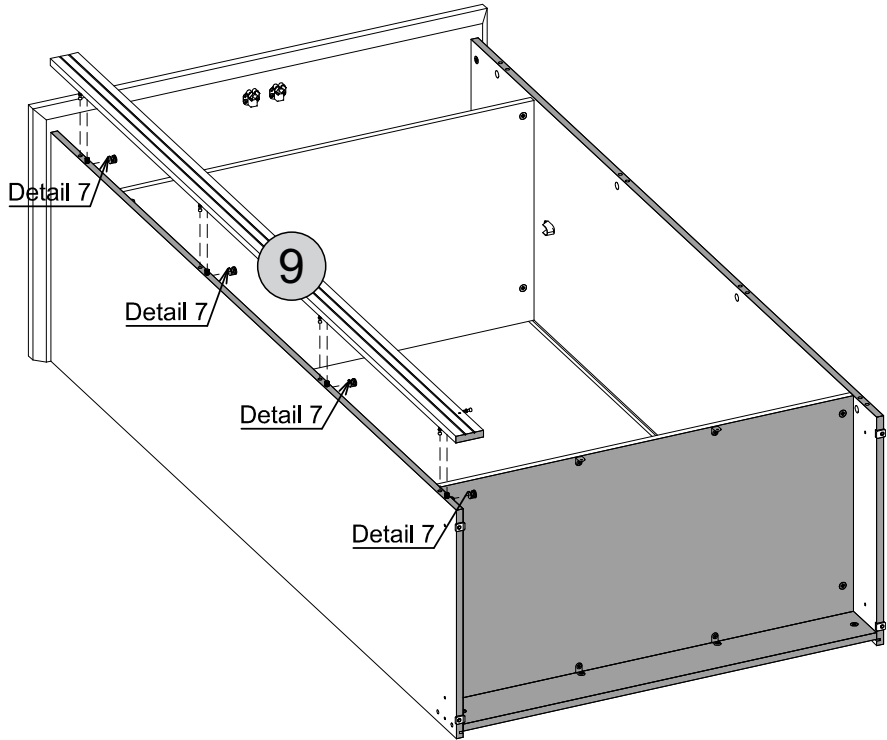
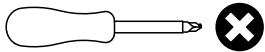

# STEP 14

## PARTS REQUIRED

4 - CROSSBEAM x1

10- RIGHT FRONT UPRIGHT x1

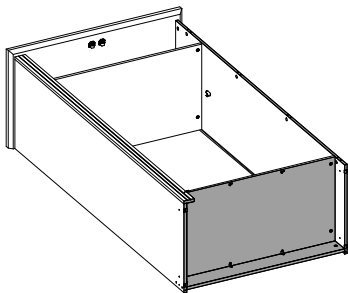

## HARDWARE REQUIRED

B  06

L  02

## TOOLS REQUIRED

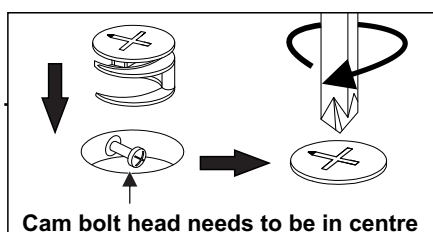
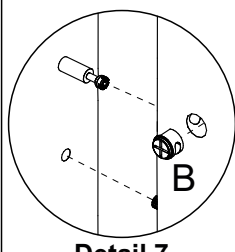
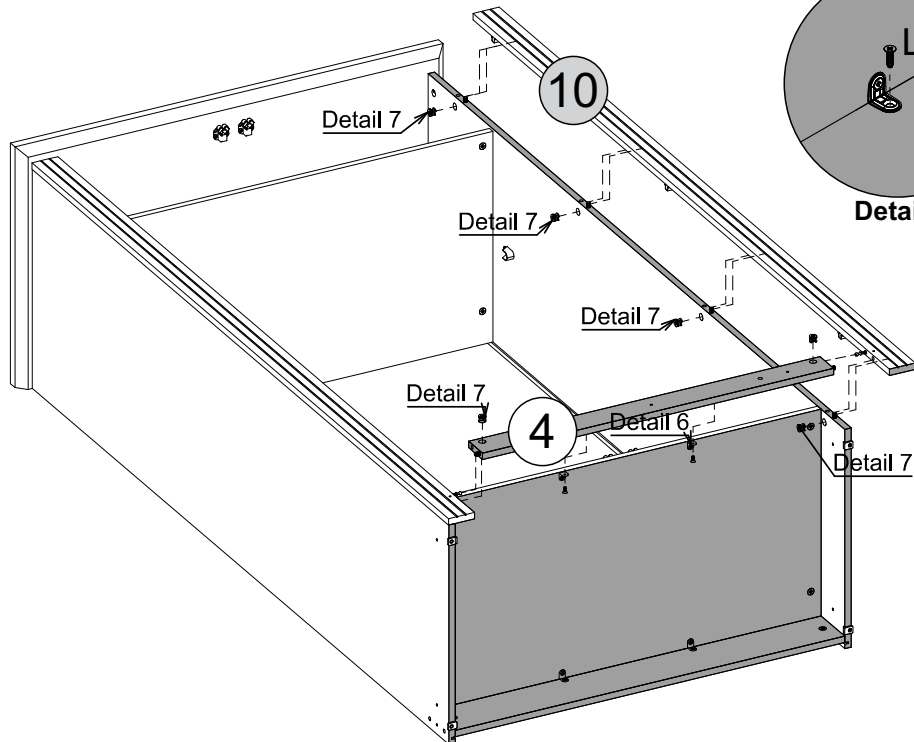
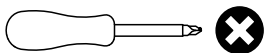

# STEP 15

## PARTS REQUIRED

12- SIDE PLINTH x2

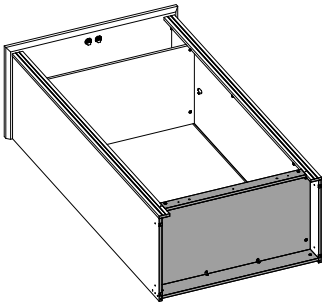

## HARDWARE REQUIRED

G  04

## TOOLS REQUIRED

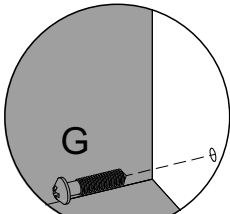
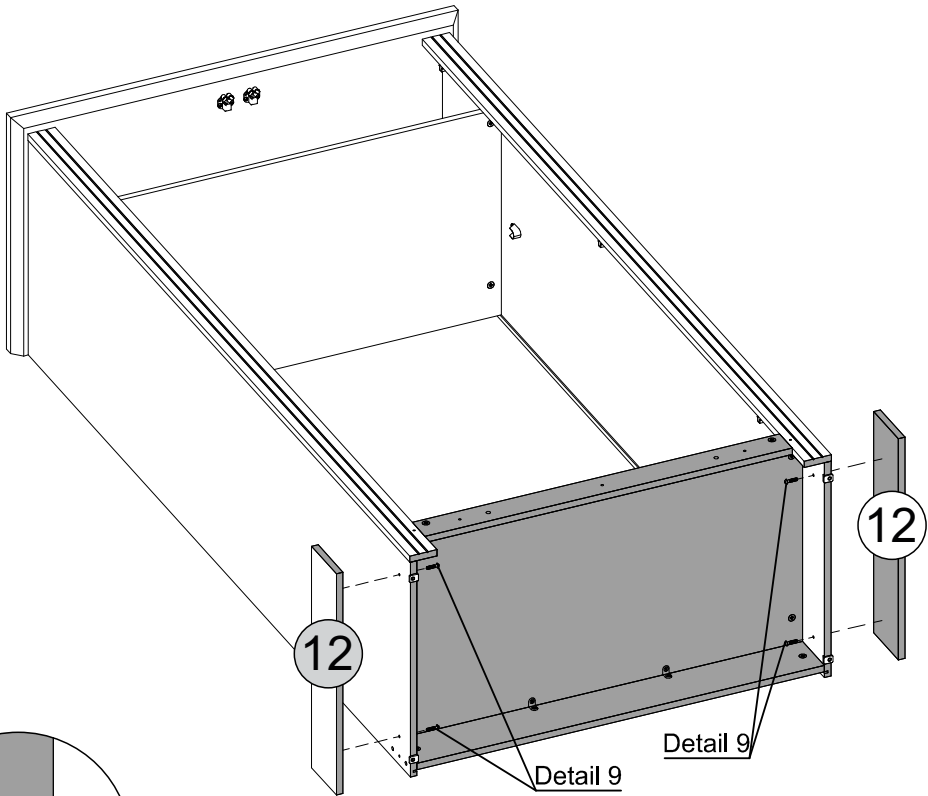
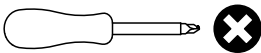

Detail 9

# STEP 16

## PARTS REQUIRED

6 - FRONT PLINTH x1

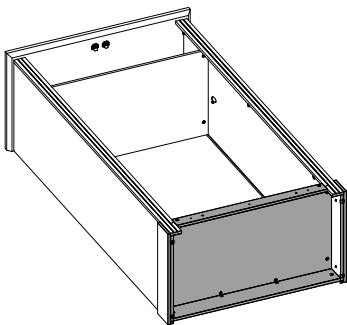

## HARDWARE REQUIRED

G  05

## TOOLS REQUIRED

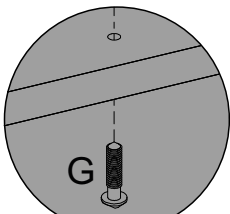
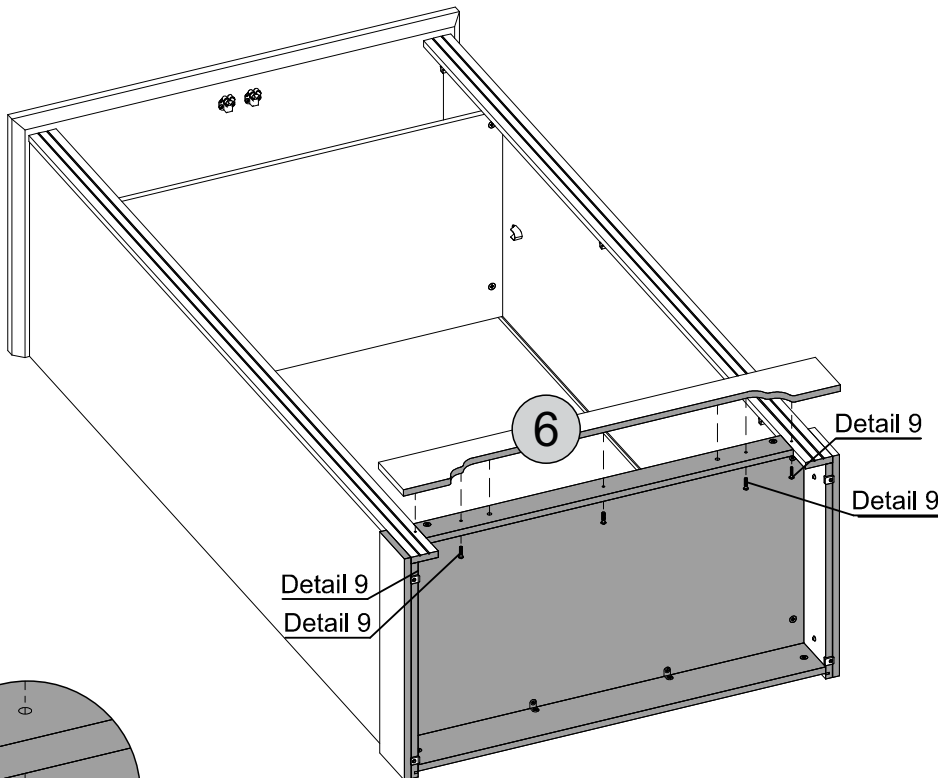
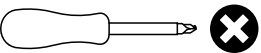

Detail 9

# STEP 17

## PARTS REQUIRED

11- BACK PANEL x2

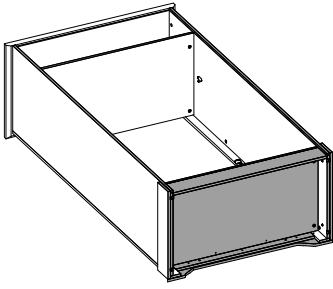

## HARDWARE REQUIRED

U  01

## TOOLS REQUIRED

\* For your future reference  
Order Number should be here

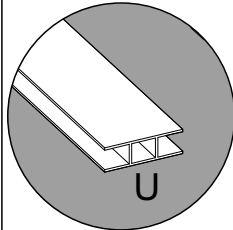
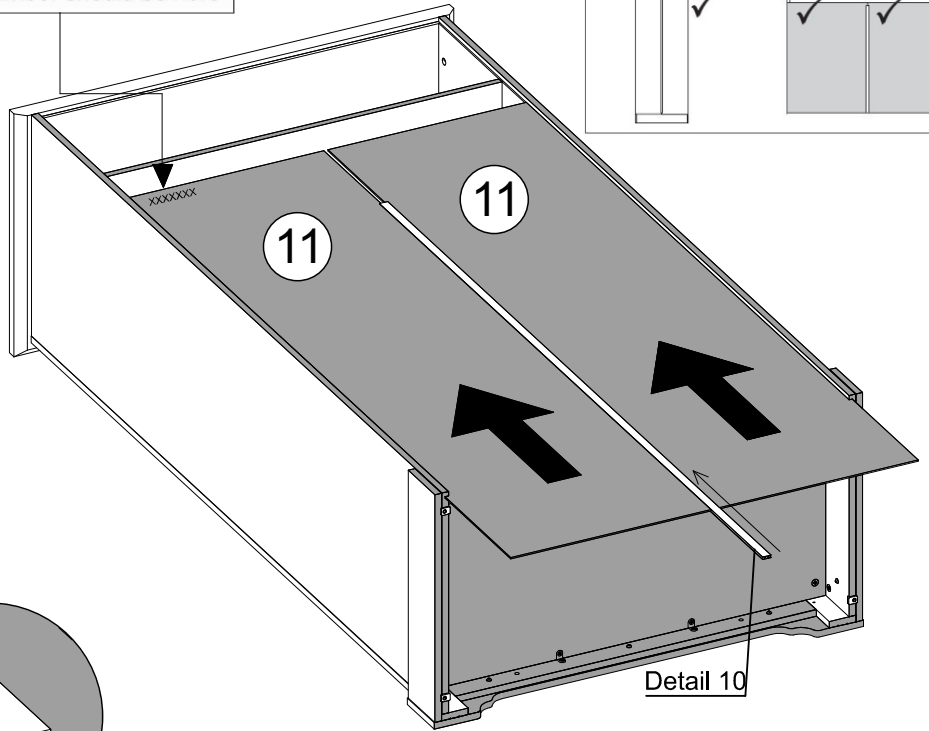
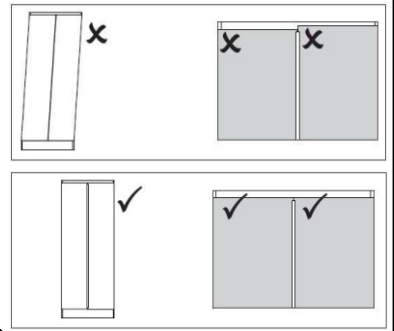

Detail 10

# STEP 18

## PARTS REQUIRED

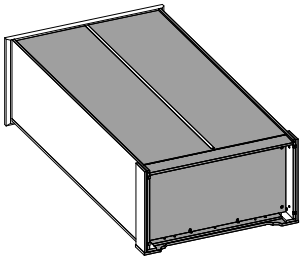

## HARDWARE REQUIRED

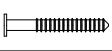
H  12

N  20

P  20

## TOOLS REQUIRED

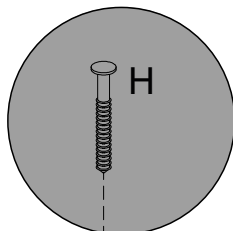
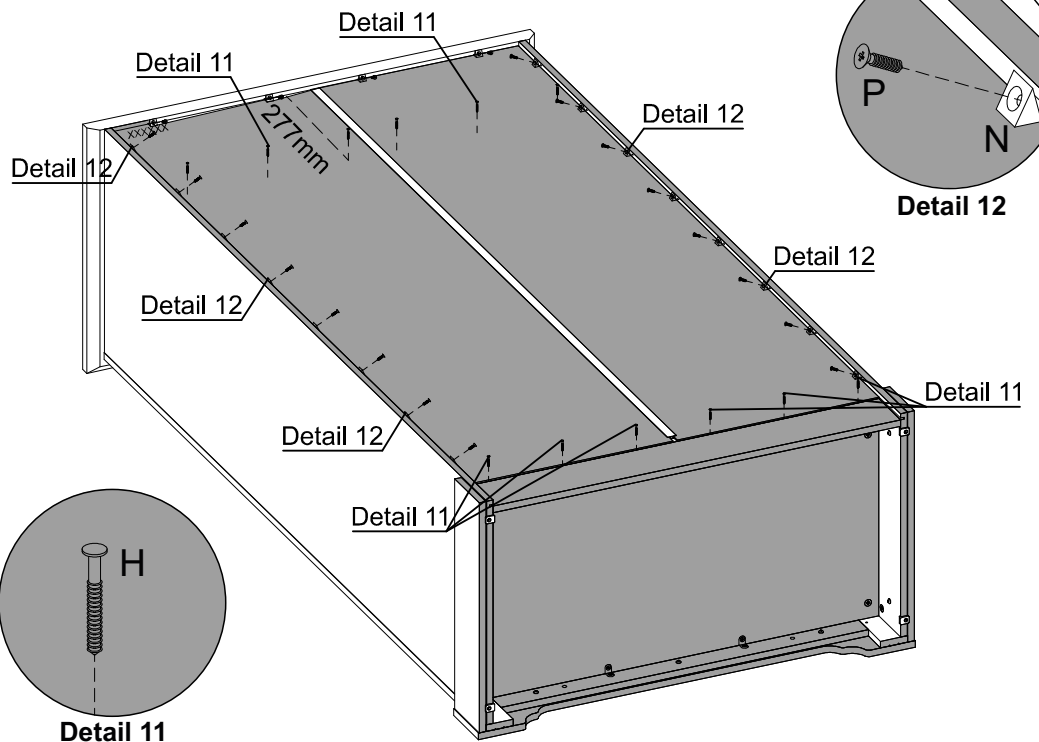
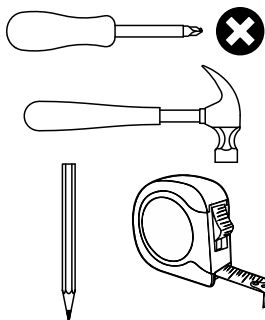

Detail 11

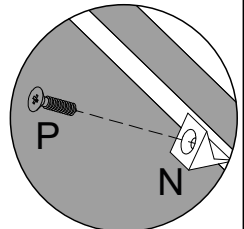

Detail 12

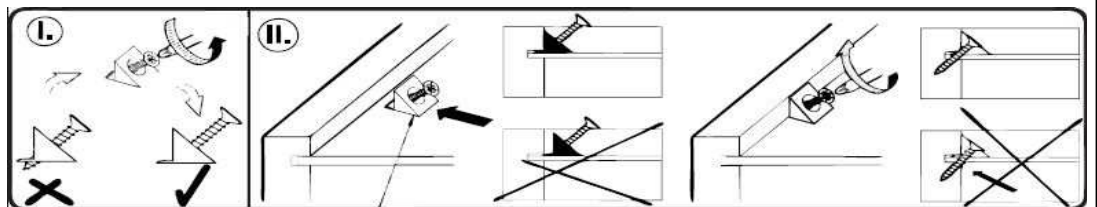

# STEP 19

**PARTS REQUIRED**

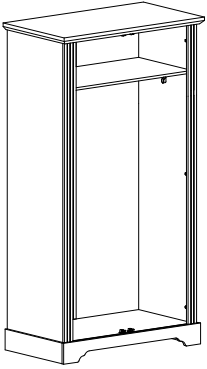

**HARDWARE REQUIRED**

K		14
S		01

**TOOLS REQUIRED**

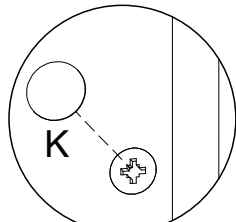

Detail 14

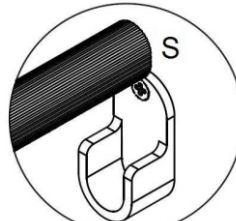

Detail 13

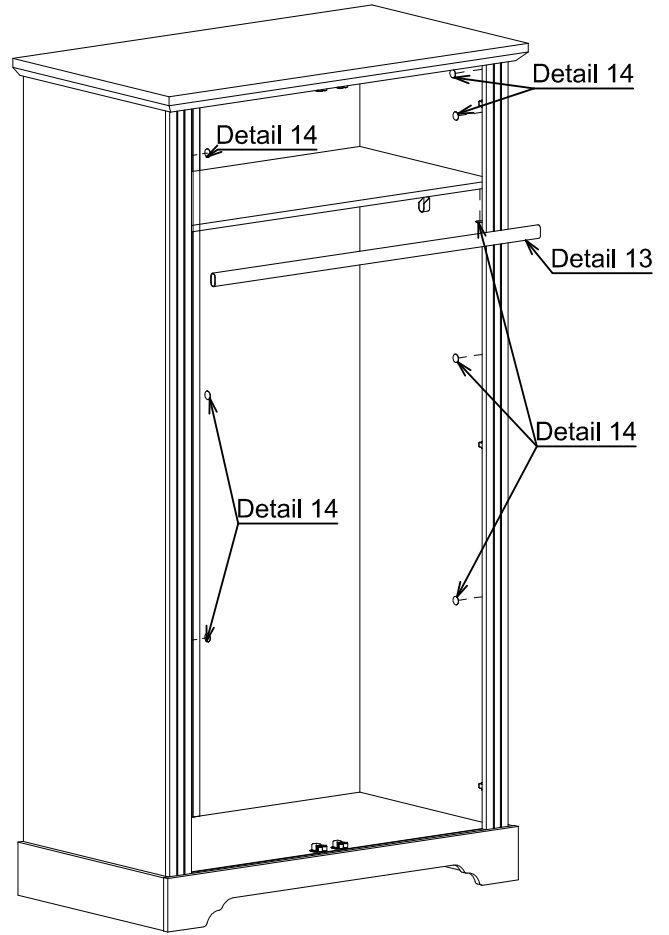

# STEP 20

**PARTS REQUIRED**

13 - DOOR	x2
-----------	----

**HARDWARE REQUIRED**

E		04
F		08
L		12
W		06

**TOOLS REQUIRED**

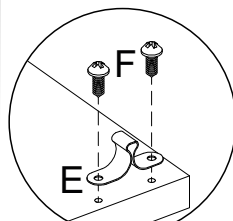
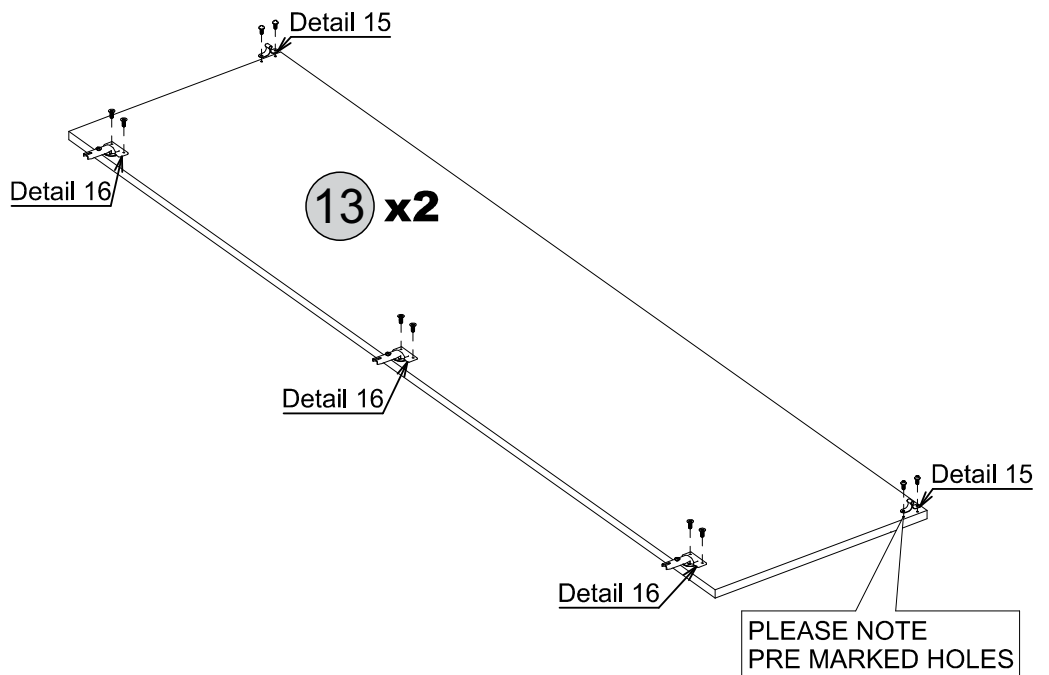
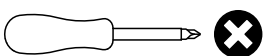

Detail 15

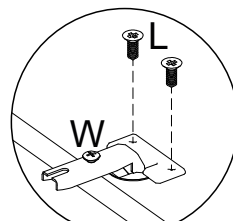

Detail 16

# STEP 21

## PARTS REQUIRED

13- DOOR x2

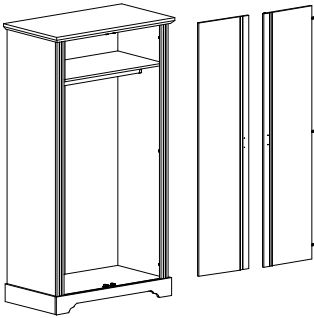

## HARDWARE REQUIRED

## TOOLS REQUIRED

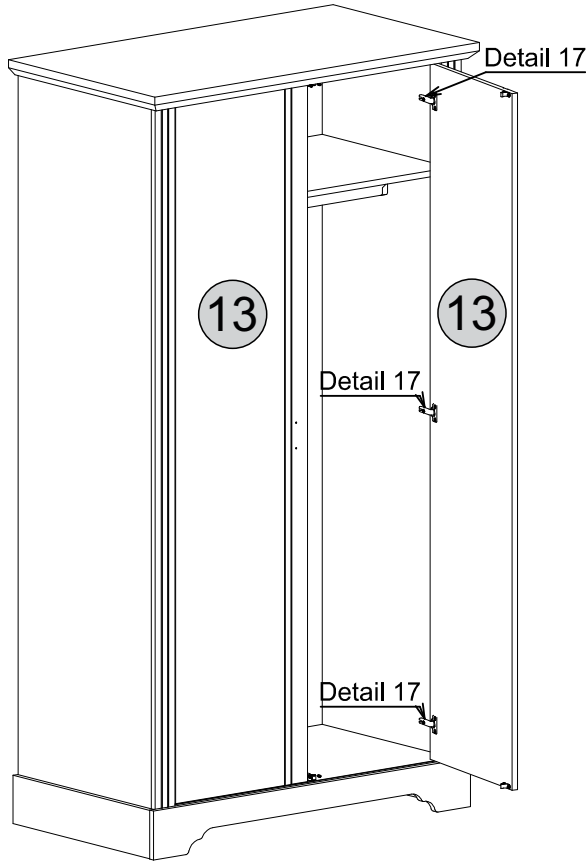
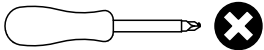

**TIP**  
If desired, after assembly use an alcohol cleaner to erase the number printed on the parts.

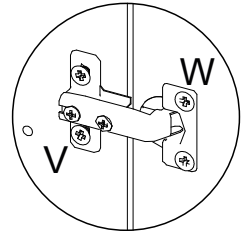
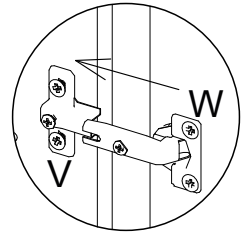

Detail 17

SHOULD THE DOORS OF YOUR WARDROBE NOT APPEAR EVEN WHEN CLOSED THEY MAY NEED ADJUSTING. THIS CAN BE DONE AS FOLLOWS: LOOSEN SCREW (V) A LITTLE. BY TURNING SCREW (W) EITHER CLOCKWISE OR ANTICLOCKWISE (IN OR OUT) THE HINGE CAN BE ADJUSTED AND THE DOOR CORRECTLY ALIGNED. IF MORE THAN ONE HINGE NEEDS ATTENTION PLEASE ADJUST ONE AT A TIME. IF IN DOUBT PLEASE SEEK PROFESSIONAL HELP.

# STEP 22

## PARTS REQUIRED

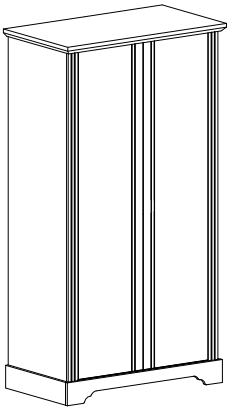

## HARDWARE REQUIRED

T 02

## TOOLS REQUIRED

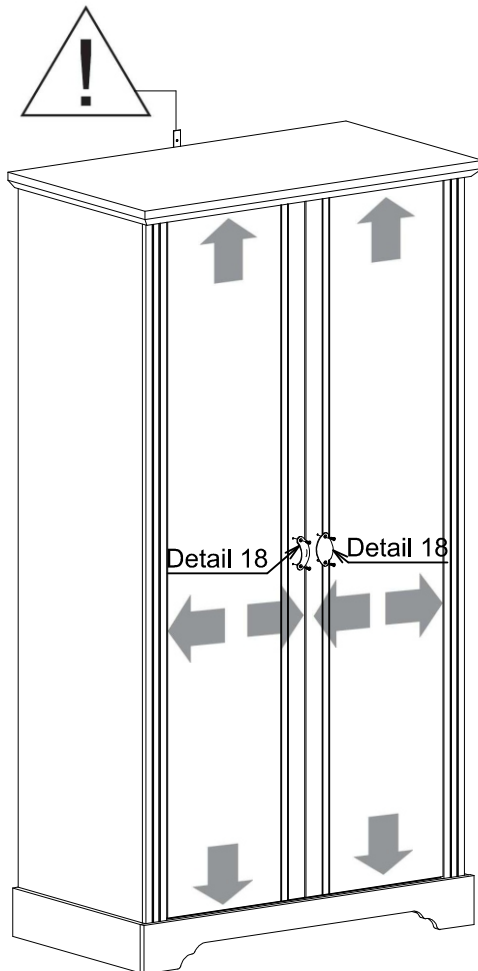
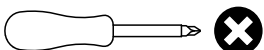

### Height Adjustment

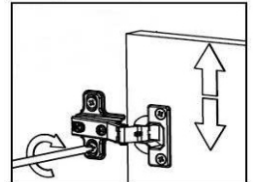

### Internal Adjustment

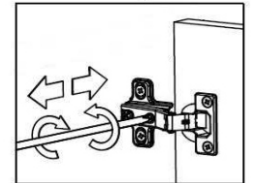

### Depth Adjustment

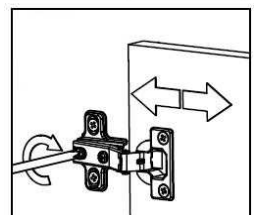
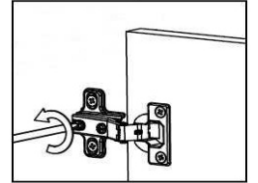

PLEASE NOTE PRE MARKED HOLES

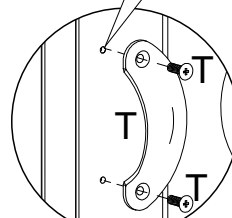

Detail 18

# STEP 23

## PARTS REQUIRED

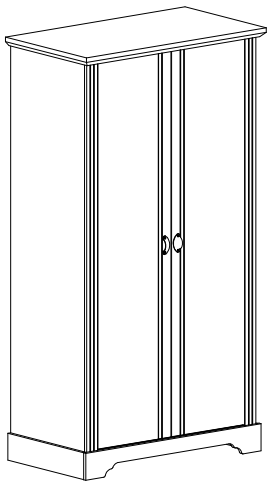

## WARNING

**Serious or fatal injuries can occur from furniture tipping over. To prevent the furniture from tipping over we recommend that it is permanently fixed to the wall.**

Wall fixings are not supplied with this product as different wall materials require different types of fixing devices. Please make sure you use fixings suitable for the walls in your home.

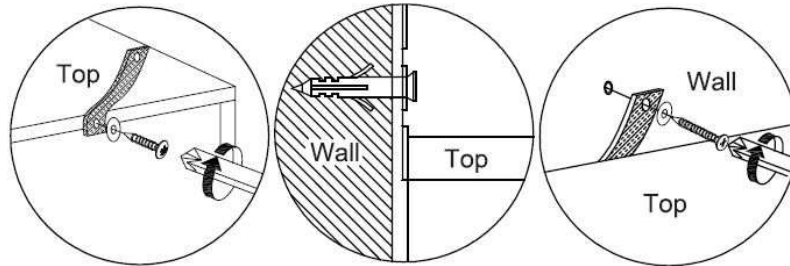

HARDWARE LIST	
	Strap (Anti-Tip Kit) (1x)
	Wood Screw (Anti-Tip Kit) 3.5 x 30mm (1x)
	Washer (Anti-Tip Kit) (2x)

## HARDWARE REQUIRED

D		02
O		01
Q		01

## TOOLS REQUIRED

