

ASSEMBLY INSTRUCTIONS
DENVER 5'0 BED PINE

IMPORTANT: READ THESE INSTRUCTIONS CAREFULLY BEFORE ASSEMBLING OR USING YOUR DENVER 5'0 BED FRAME

PLEASE KEEP THESE INSTRUCTIONS FOR FUTURE REFERENCE

HEALTH & SAFETY:

DO NOT jump on this bed frame
DO NOT use this bed frame if any parts are missing, damaged or worn
DO NOT use this bed frame unless all fixings are secured
Always use on a level, even surface

WARNING: If this bed is placed on a laminated floor you must place some protection under all legs to stop the bed frame from moving. If this is not adhered to there is no guarantee if the bed frame collapses

CARE & MAINTENANCE:

Periodically check all screws & fixings to ensure they are secure
DO NOT push the bed frame as this will damage the legs
Always lift the bed with two people to reposition
Keep any sharp objects away from the frame

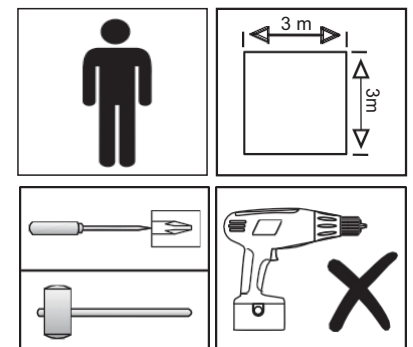
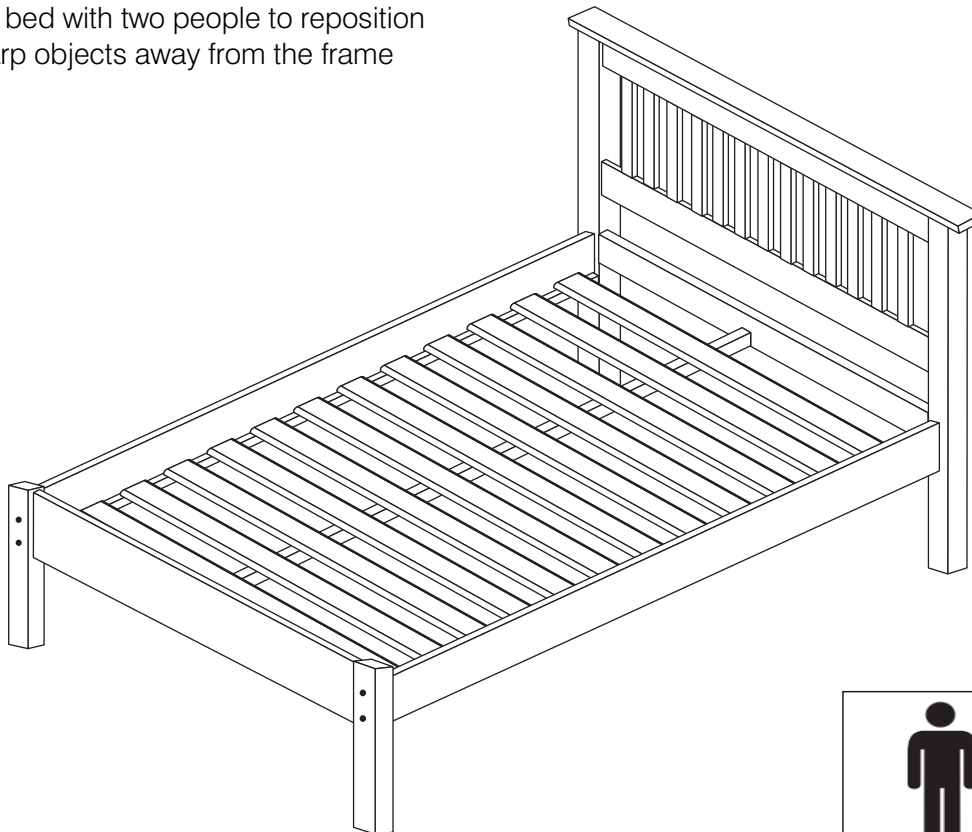

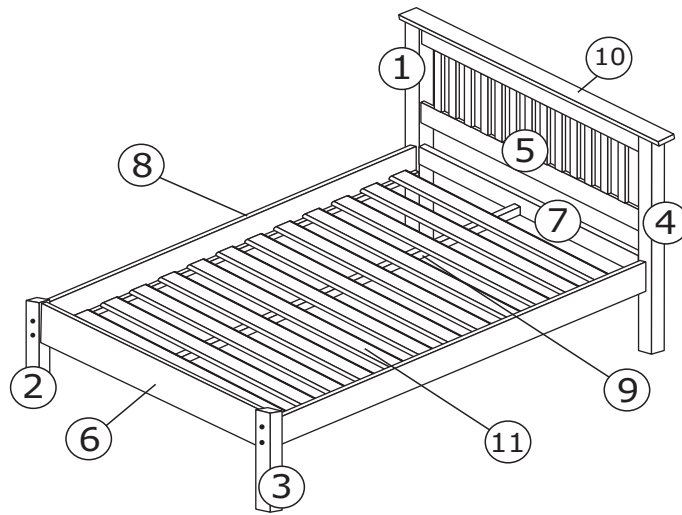

PARTS LIST				HARDWARE LIST (FOUND IN BOX 02)			
No	Item	Qty	Box	No	Item	Qty	
1	Post Headend	1	01	A	¼* 90 mm Bolt	8	
2	Post Footend	1	01	B	4*35 mm Screw	26	
3	Post Footend	1	01	C	10 x 40 mm Wooden Dowel	12	
4	Post Headend	1	01	D	¼ Elliptical Nut	8	
5	Grids	1	01	E	Allen Key	1	
6	Footend Rail	1	01	F	4*16 mm Screw	10	
7	Headend Rail	1	01	G	7 x 90 mm Bolt	8	
8	SideRail	2	02	H	7 x 80 mm Bolt	4	
9	Centre Rail	1	02	I	GLUE	1	
10	Plinth	1	02	J	Spacer Block	2	
11	Slat	13	01	K	Screw Cap	16	
				L	Bracket	2	

**** you will need a small mallet and a screwdriver**

Step 1 - Use the foot (1) and (4) with the parts (5) and (7) to assemble the headboard. In parts (5) and (7) use the hardware (C) applying the glue (I). Fit in the feet (1) and (4) to the parts (5) and (7), using the hardware (G) + (E) to fix it, once it's done put the hardware (K) on the top of screw. Use the foot (2) and (3) together with the part 6 to assemble the footboard. Use hardware (C) applying glue (I). Fit in the feet (2) and (3) with the part 6, fix these parts with the hardware (G) and (E) on the screw tips.

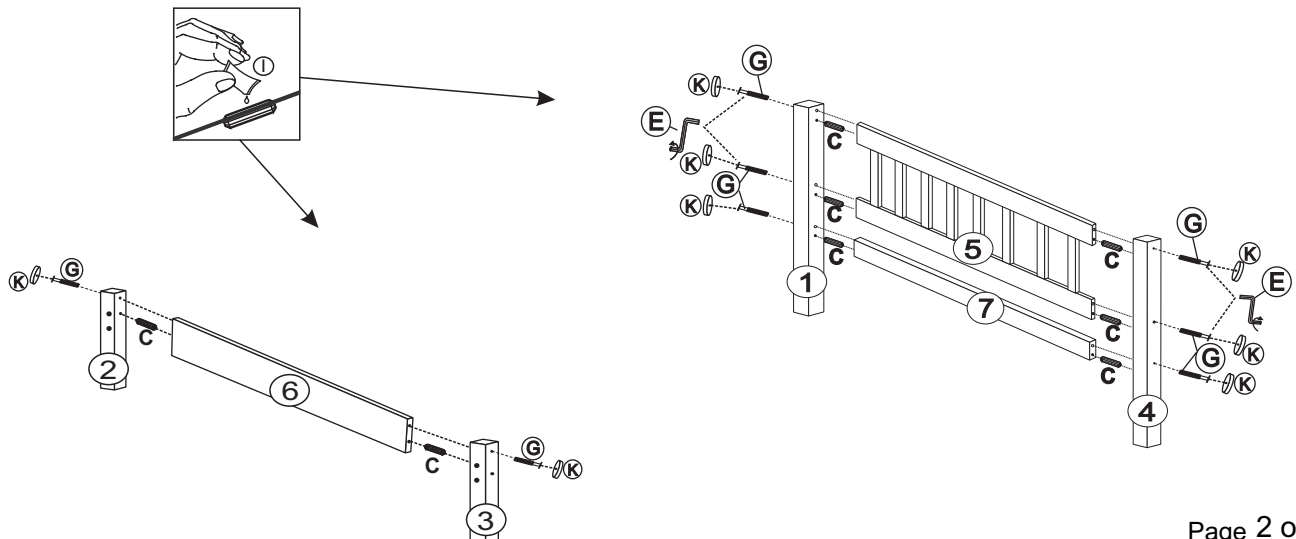

Step 2: Attach a plinth (10) to the headend (5) using hardware part H.

DO NOT use any power tools as this may damage the frame and will invalidate any claim

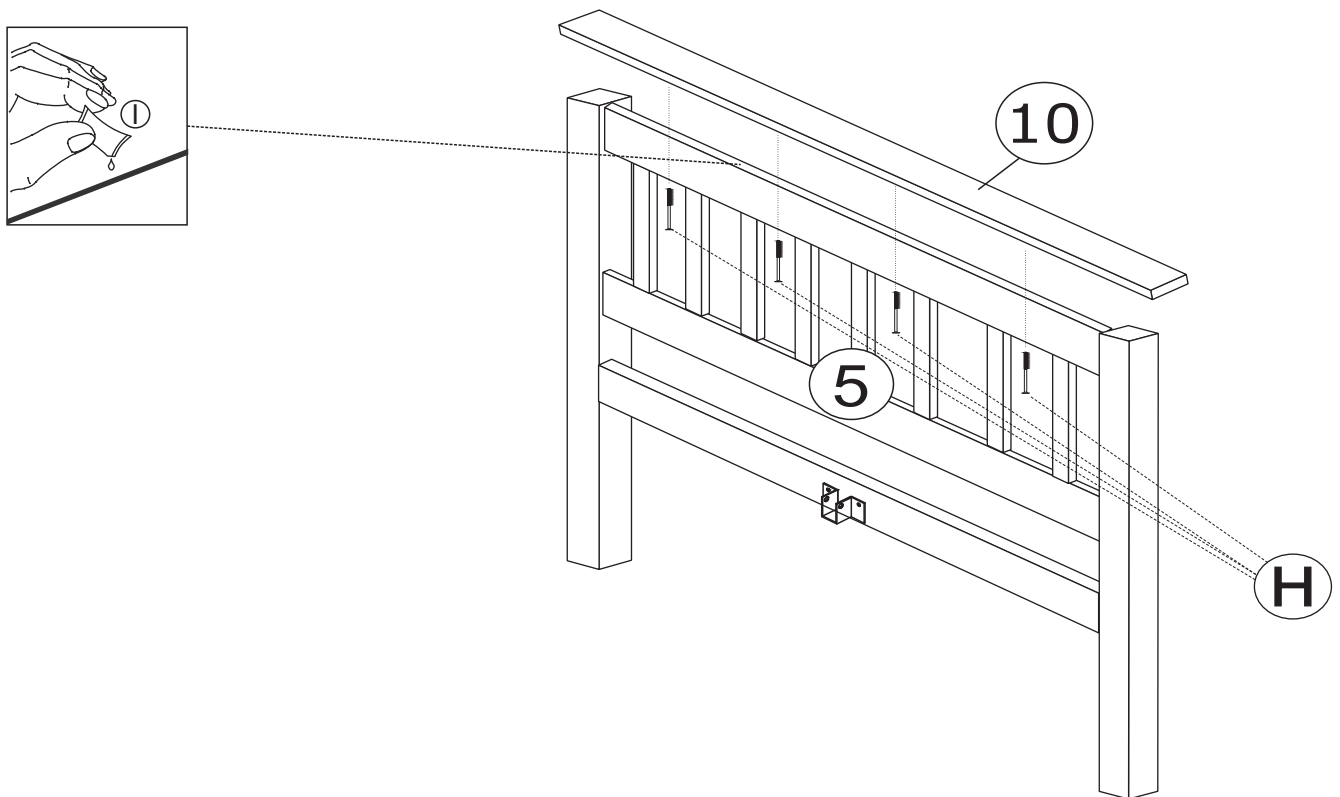

Step 3: Fix hardware part L to the headend (7) using hardware part F, then attach the side rails (8) using hardware parts A, C and E

DO NOT use any power tools as this may damage the frame and will invalidate any claim

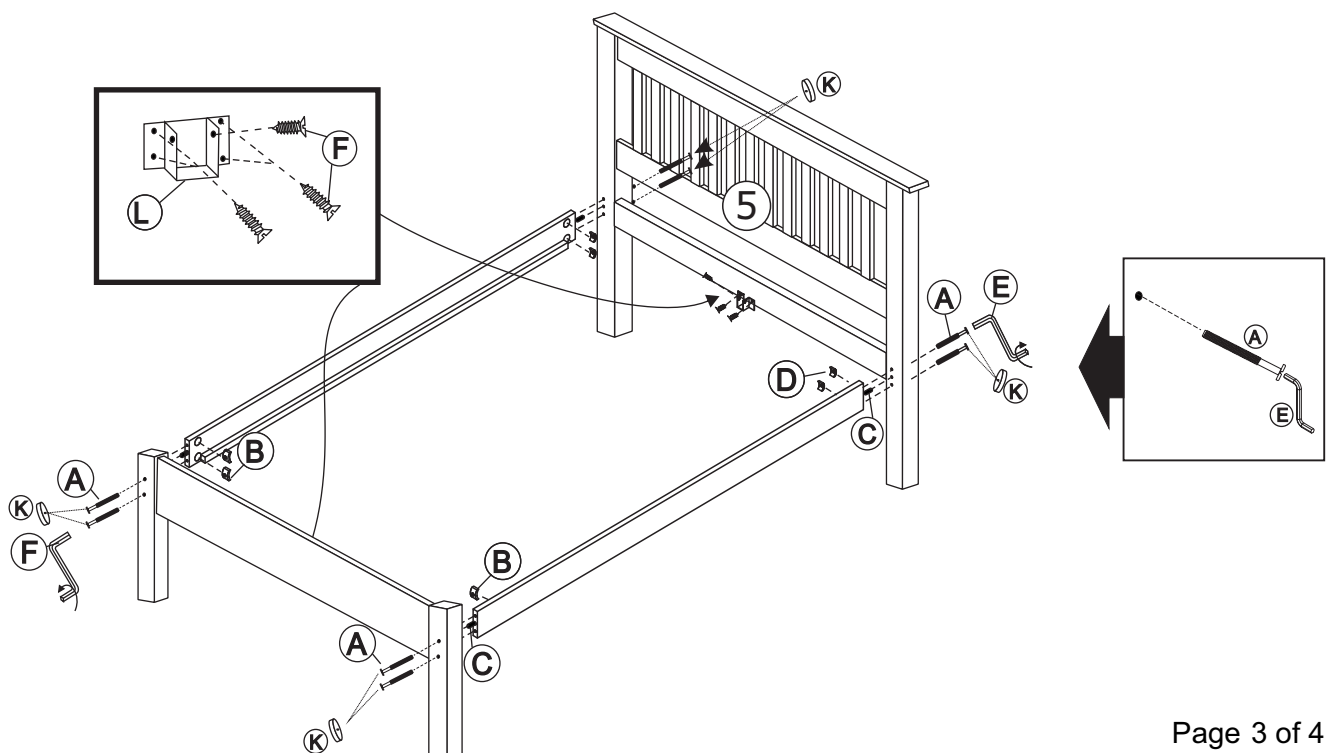

Step 4: Secure the centre rail (9) using hardware part F

DO NOT use any power tools as this may damage the frame and will invalidate any claim

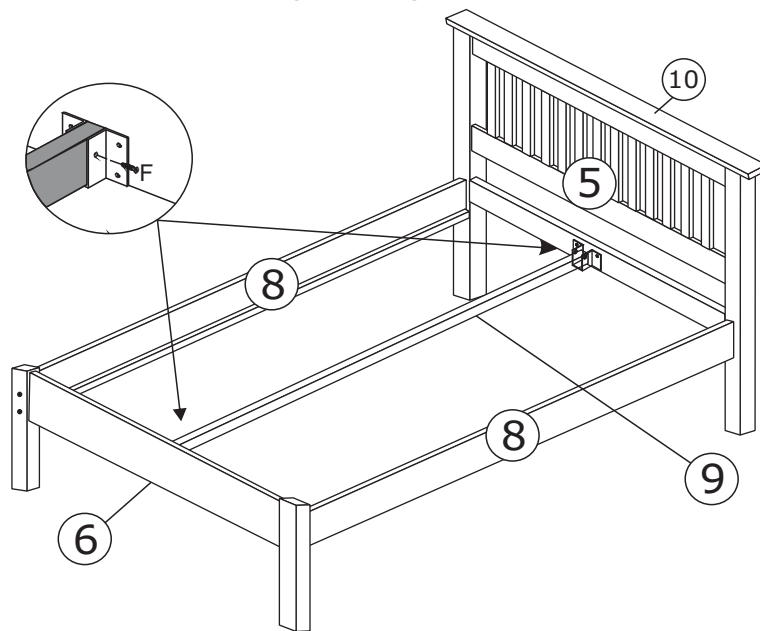

Step 5: Fix the slats (11) into position whilst applying pressure to both side rails (8) using hardware parts B and J and a screwdriver (not provided)

DO NOT use any power tools as this may damage the frame and will invalidate any claim

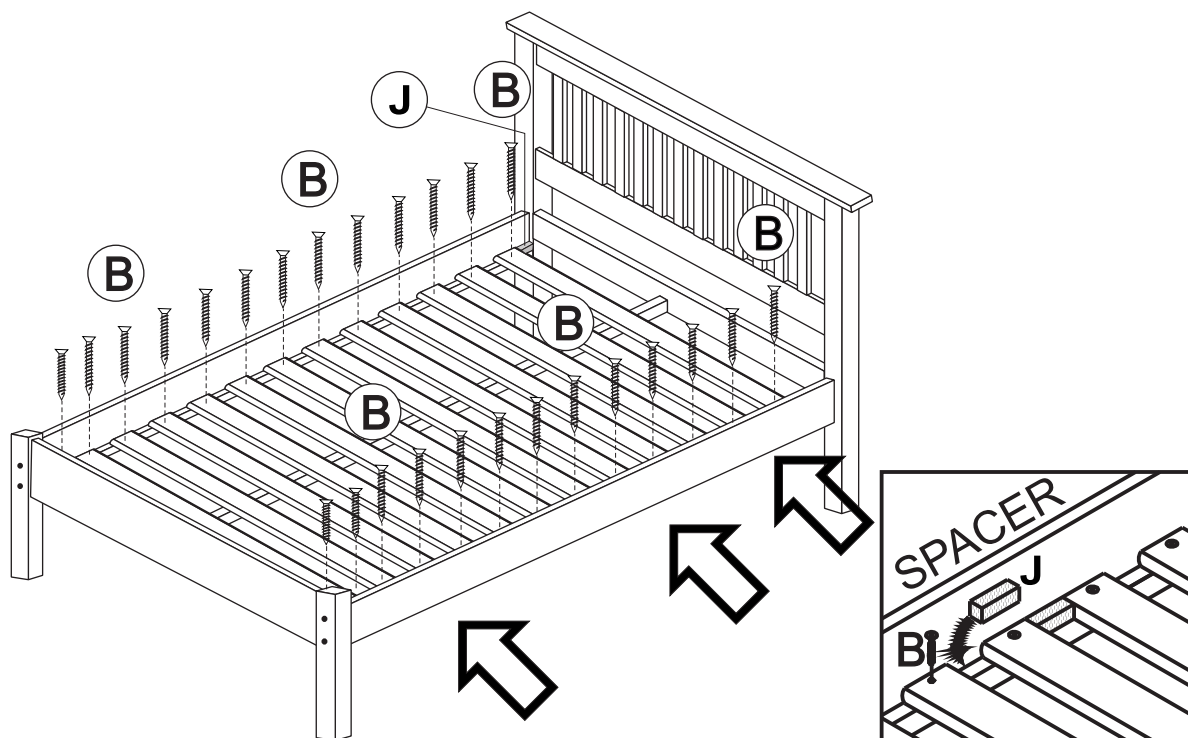

Additional Information:

- For complete product information, images and dimension diagrams please visit the website www.birlea.com
- If you have any issues with your item please contact the retailer directly you purchased it from who will be able to resolve any issues with Birlea.
- Why don't you send us photos of your assembled furniture to info@birlea.com to be shared in our #birleahome feature on Instagram.